

Gas Logs

Section 500

2
0
2
5
-
2
0
2
6

Page Number	Vendor	Product	Sold Regionally	Publish Date
501-502	RH Peterson	POP and How To		03/24
503-508	RH Peterson	"Easy Sheets" for Logs and Burners		03/24
509-511	RH Peterson	Standard Gas Logs - Charred, Designer & Classic Series		03/24
511-513	RH Peterson	Standard Burner Systems (G4, G45, G46, FP, PB, G22)		03/24
514	RH Peterson	See-Thru Gas Log Sets		03/24
514-516	RH Peterson	See-Thru Burner Systems		03/24
516-518	RH Peterson	Specialty Gas Logs & Burners		03/24
519	RH Peterson	Safety Control Systems & Remote Compatible Options		03/24
520	RH Peterson	Glass Media & GEO Shapes		03/24
521-522	RH Peterson	Accessories		03/24
523-524	RH Peterson	Vent Free Systems		03/24
525	RH Peterson	Vent Free Accessories		03/24
527-528	Hargrove	Vented Loose Logs (Fresh Cut, Charred & Radiant)	✓	01/25
528	Hargrove	E-Burner Vented Kits	✓	01/25
529	Hargrove	H-Burner Vented Kits	✓	01/25
529	Hargrove	System 4 Burner Kits	✓	01/25
530	Hargrove	Hidden Control Vented Burner Kits	✓	01/25
530	Hargrove	Large Burner Kits	✓	01/25
530	Hargrove	Large Vented Log Sets (Mountain Timber)	✓	01/25
530	Hargrove	Kodiak Double Stack Logs	✓	01/25
531	Hargrove	See Thru Vented Log Sets	✓	01/25
531	Hargrove	See Thru Vented Burner Kits	✓	01/25
531	Hargrove	See Thru Shallow Vented Logs	✓	01/25
531	Hargrove	See Thru Shallow Vented Burner Kits	✓	01/25
531	Hargrove	See Thru System 4 Shallow Vented Burner Kits	✓	01/25
532	Hargrove	Full Pan Vented Burner Kits	✓	01/25

Continued on next page...

For same day shipping, place order by: 1pm (CO), 2pm (CA, WA) and 11am (MN, TX). Give us a call at 1-800-682-9722

Associated Energy Systems - Serving you with distribution centers in: Kent, WA | West Sacramento, CA | Denver, CO | Dallas, TX | Rogers, MN

Stock: Y = Stock, N or * = Non-Stock, LTSD = Limited to Stock on Hand

Non-Stock Item Notice: Items marked non-stock must be ordered in case quantities

Gas Logs

Section 500

2
0
2
5
-
2
0
2
6

Page Number	Vendor	Product	Sold Regionally	Publish Date
532	Hargrove	Full Pan Specialty Shapes	✓	01/25
532	Hargrove	Burner Media Options	✓	01/25
533	Hargrove	Outdoor Log Burner Kit and Firepit Logs	✓	01/25
534	Hargrove	Olde World Basket	✓	01/25
534	Hargrove	Pinnacle Logs and Burner Kits	✓	01/25
535	Hargrove	Safety Pilot Controls, Pilot Kits and Parts	✓	01/25
536	Hargrove	Gas Valves, Switching Accessories, Ignition Systems	✓	01/25
NEW 537	Hargrove	Control System Concealer (CSC)	✓	01/25
538	Hargrove	Refractory Panels, Individual Logs and Parts	✓	01/25
NEW 539	Hargrove	Cimarron Timbers Vent Free Log Sets and Accessories	✓	01/25
NEW 540	Hargrove	Birch Timbers Vent Free Log Sets and Accessories	✓	01/25
541	Hargrove	Yukon Char Vent Free Log Sets and Accessories	✓	01/25
542	Hargrove	Heritage Char Vent Free Log Sets and Accessories	✓	01/25
543	Hargrove	Charleston Glow Vent Free Log Sets and Accessories	✓	01/25
544	Hargrove	Element Series Vent Free Log Sets and Accessories	✓	01/25
545	Hargrove	Weathered Oak Vent Free Log Sets and Accessories	✓	01/25
546	Firegear	Media and Accessories		11/22
547	Fireglass Plus	Glass, Media, Burners and Accessories		03/19

PLEASE NOTE: Not all products are sold throughout all AES territories/regions. If "Sold Regionally" please contact AES Inside Sales for availability 800-682-9722

Or by visiting...

shop.aes4home.com



For same day shipping, place order by: 1pm (CO), 2pm (CA, WA) and 11am (MN, TX). Give us a call at 1-800-682-9722

Associated Energy Systems - Serving you with distribution centers in: Kent, WA | West Sacramento, CA | Denver, CO | Dallas, TX | Rogers, MN

Stock: Y = Stock, N or * = Non-Stock, LTSD = Limited to Stock on Hand

Non-Stock Item Notice: Items marked non-stock must be ordered in case quantities

RH PETERSON
REAL Fyre™ GAS LOGS



2
0
2
5
-
2
0
2
6

The RH Peterson Company provides the highest possible degree of durability which is why Associated Energy Systems has been offering Real Fyre™ products to its customers for over 20 years.

Real Fyre™ logs are formulated from kiln-fired ceramics, superior refractories and the best expanded shales and aggregates. Their durability has been proven for over 50 years of use in American homes. The high temperatures of a burning fireplace pose no challenge to the beauty, strength and durability of Real Fyre™ Gas Logs. They meet nationally recognized standards and earn approval of local and national building code authorities throughout America.

Real Fyre™ Gas Logs duplicate the detailed bark pattern and texture of real wood through a unique molding system. Knot holes, peeled bark, forked branches and other natural enhancements add realistic appearance. These logs are then colored by an exclusive immersion/filtration system. Many of the logs are then hand painted, detailed or accented to provide the most realistic looking logs available. Real Fyre™ logs are sized and matched to create a balanced natural wood stack that works with Real Fyre™ burner systems to provide an authentic wood fire appearance. Yet, there is more to Real Fyre™ Gas Logs than their beauty.

Because the logs are manufactured with non-conductive ceramic, they reflect more radiant heat off their surface. This helps the gas burner system burn more efficiently. The heat chamber, a development of the Peterson Company, consistently radiates more BTU's of heat into the room without the hot and cold zones normally created by the varying size of a wood fire. The heat chamber also adds to the warmth and Real Fyre™ Gas Logs promote cleaner burning.

Instant on/off finger tip control provides immediate flame at the simple turn of the valve. No more messy ashes to clean up, no storing of dirty firewood and no more dangerous flying sparks with Real Fyre™ Logs. Creosote build-up in the chimney, a common cause of fires, is also eliminated by the clean burning gas fuel.



Real Fyre™ Gas Logs feature a Lifetime Warranty. Vented Burner Assemblies feature a 5-year Warranty.

Showroom Display Materials

Showcase your Peterson Real Fyre™ Gas Logs and the important accessories with these attractive, 3-Tier Gas Log Displays. Made of sturdy steel construction, 66"H x 32"W x 17"D assembled. Log shelves support sets up to 24" wide, have a 1" lip to prevent sand, embers and lava granules from spilling on to your floor. The shelves are also just right for displaying a small amount of hearth accessory stock.

Item No.	Description	Net Dealer Cost
RHRFD05A	3-Tier Log Display Rack	\$600.00
RHRFDA8	Accessory Display Rack	600.00
RHSUBDVI02	Direct Vent Insert Logs Retractable Banner with Stand	\$90.00
RHSUBRF02	Vented Log Collection Retractable Banner with Stand	\$90.00



3 Tier Log Display Rack

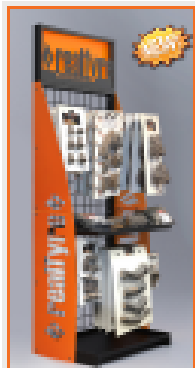

Accessory Display Rack



DVI Logs Banner



Vented Logs Banner

Gas Logs

To use this Price Sheet -



1. Select log style design or contemporary media



Purchase Info. Key
 • For all model numbers: **= Insert Size
 • All prices: \$
 • Weight: #

GAS LOG STYLE CODES

CHARRED SERIES	
CHD:	Charred Oak
HCHR:	Burnt Rustic Oak
CHS:	Charred Split
CHRRSO:	Charred Rugged Split Oak
CHAO:	Charred American Oak
CHN:	Charred Northern Oak
CHB:	Charred Royal English Oak
CHMJ:	Charred Majestic Oak
CHNA:	Charred Angel Oak
CHNS:	Charred Angel Split Oak
CHMBW:	Charred Mountain Birch
ENO:	Charred Evergreen Oak *
ENS:	Charred Evergreen Split Oak *
BTA:	Burnt Aspen *

DESIGNER SERIES	
RDP:	Golden Oak Designer Plus
HRD:	Rustic Oak Designer
AO:	American Oak
S:	Split Oak
SDP:	Split Oak Designer Plus
RRSO:	Rugged Split Oak
WO:	Woodland Oak
MBW:	Mountain Birch
W:	White Birch
BD:	Royal English Oak Designer
GSO:	Gnarled Split Oak
CN:	Chestnut Oak
RFS:	Rugged Forest Split
MCO:	Mountain Crest Oak *
MCS:	Mountain Crest Split Oak *
COLO:	Colonial Oak *

CLASSIC SERIES	
R:	Golden Oak
HR:	Rustic Oak
RRO:	Rugged Oak
PO:	Post Oak
B:	Royal English Oak
CDR:	Coastal Driftwood

See page 8 for See-thru Gas Log Sets

CONTEMPORARY MEDIA CODES

FYRE GLASS	
GL-F:	Azuria
GL-B:	Black
GL-Z:	Bronze
GL-N:	Caribbean Blue
GL-C:	Clear
GL-E:	Emerald
GL-W:	Star Fyre

FYRE GEMS	
GLG-J:	Black Pearl
GLG-T:	Blue Topaz
GLG-D:	Champagne
GLG-A:	Deep Amber
GLG-E:	Emerald
GLG-C:	Glacier
GLG-S:	Sapphire
GLG-RY:	Ruby

REFLECTIVE FYRE GLASS	
GL-FR:	Azuria Reflective
GL-BR:	Black Reflective
GL-ZR:	Bronze Reflective
GL-NR:	Caribbean Blue Reflective
GL-QR:	Copper Reflective
GL-ER:	Emerald Reflective
GL-HR:	Gold Reflective
GL-CR:	Champagne Reflective

DIAMOND NUGGETS	
GLD-C:	Clear
GLD-SB:	Steel Blue
GLD-R:	Rosé
GLD-E:	Emerald
GLD-PB:	Pacific Blue
GLD-DB:	Deep Black

FOR P45 BURNER	
EB:	Epic Black Fyre Spheres *
GS:	Graystone Fyre Spheres *
SO:	Shoreline Designer Oak *
SDW:	Shoreline Driftwood *

See Pages 14 & 15 for FYRE SPHERES & RIVER ROCK

* Log sets are only compatible with specific specialty burners - see Section V.

2. Select burner system



G45-24-02

BURNER STYLE CODES

LISTED BURNERS	
G4:	Glowing Ember
G45:	Triple T Burner
GX45:	Heavy Duty Triple T Burner
G45-GL:	Triple T Glass Burner
PB:	Pan Burner (For Glass)

ANSI CERTIFIED BURNERS	
G45(A):	Triple T Burner
G45(A-SS):	Triple T Stainless Steel
G45-GL(A):	Triple T Glass Burner
G45-GL-SS:	Triple T Stainless Glass
G46:	Glowing Ember
PB(A):	Pan Burner (For Glass)
P45:	Tapered Pan Burner
G31:	3-Tiered Burner
G52:	Radiant Fyre Burner
G52-SS:	Radiant Fyre Burner Stainless Steel

See pages 8 - 9 for See-thru Burner Systems

3. Select size

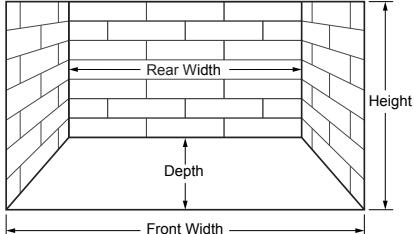

4. Select controls

(Page 13)



APK-15

5. Select accessories

(Pages 15-16)



DP-7 DECOR PACK
Featuring Bryte Coals

Stock: Y = Stock, N or * = Non-Stock, LTSD = Limited to Stock on Hand

realfyre PREMIUM GAS LOGS

Manufacturing the highest quality gas logs for 75 years

Split Oak
Designer Plus



American Oak



Charred Rugged
Split Oak



- Handcrafted Logs
- Unmatched Beauty
- With a Flip of a Switch
- Clean Burning
- Convenient
- Warmth & Ambiance
- Naturally Detailed
- Meticulously Crafted
- Intricate Bark Detail

Questions?

Contact your AES Sales Staff: (800) 682-9722

AES

realfyre G45 BURNER

Choose Your Burner - Choose Your Log Set

G45**

- G45 Burner System, No Safety Pilot Kit, No Remote, Natural Gas Only
- Sizes: 18"/20" - 24"/30"

G45**17

- G45 Burner System with "17" Series Valve & Variable Remote
- Propane Option: G45**17P
- Sizes: 18"/20" - 24"/30"

G45**02

- G45 Burner System with "02" Electronic Valve & On/Off Remote
- Propane Option: G45**02P
- Sizes: 18"/20" - 24"/30"

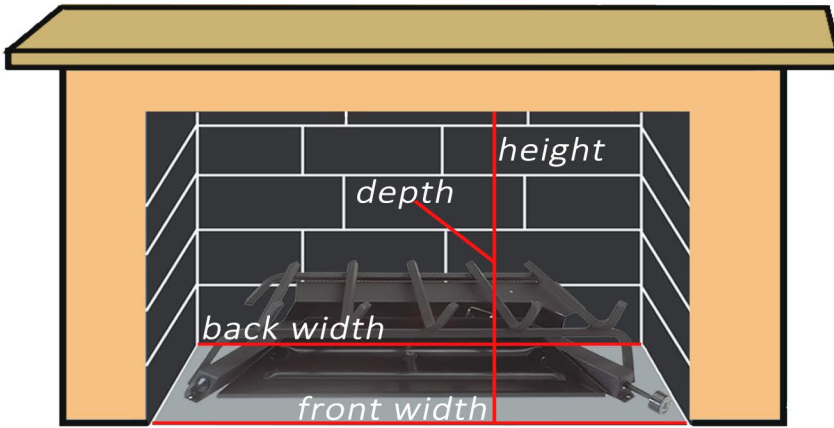

For Proper Installation
Measure the dimensions of firebox.
Width - Bottom of Firebox, Front & Back
Depth - Front to Back
Height - Bottom to Top



The G45 and GX45 Burner Systems are ANSI Certified and accentuate the front flame and ember bed of the log set.

Model	Minimum Fireplace Size				BTU Rating	
	Width*		Depth‡	Height	Nat. Gas	L.P. Gas
	Front	Rear†				
G45-16/19	29"	22"	11"	17"	40K	30K
G45-18/30	30"	24"	13"	17"	40K	45K
G45-24	34"	28"	13"	17"	90K	65K
G45-30	40"	34"	16"	17"	95K	75K
G45-36	46"	40"	16"	17"	110K	90K

* These required widths allow for centering of the unit.
For 02 models, add 2" to both front and rear width.
† Rear width is at corresponding depth.
‡ If an ash lip exist, the depth requirement begins inside of the lip.

Premium Gas Logs	18"	24"	30"	Burner Kit	18/20"	24"	30"
Split Oak Designer Plus	\$422	\$497	\$645	G45**	\$338	\$366	\$429
American Oak	\$474	\$548	\$695	G45**17	\$1,007	\$1,030	\$1,093
Charred Rugged Split Oak	\$493	\$561	\$727	G45**02	\$1,351	\$1,380	\$1,447

Questions?

Contact your AES Sales Staff: (800) 682-9722

March 2024 Pricing

AES

realfyre PREMIUM GAS LOGS

Manufacturing the highest quality gas logs for 75 years

Split Oak



Charred Oak



Charred American Oak



- Handcrafted Logs
- Clean Burning
- Naturally Detailed
- Unmatched Beauty
- Convenient
- Meticulously Crafted
- With a Flip of a Switch
- Warmth & Ambiance
- Intricate Bark Detail

Questions?

Contact your AES Sales Staff: (800) 682-9722

AES

realfyre G46 BURNER

Choose Your Burner - Choose Your Log Set

G46**

- G46 Burner System with Safety Pilot Kit, No Remote
- Propane Option: G46**P
- Sizes: 18"/20" - 24" - 30"

G46**17

- G46 Burner System with "17" Series Valve & Variable Remote
- Propane Option: G46**17P
- Sizes: 18"/20" - 24" - 30"

G46**02

- G46 Burner System with "02" Electronic Valve & On/Off Remote
- Propane Option: G46**02P
- Sizes: 18"/20" - 24" - 30"

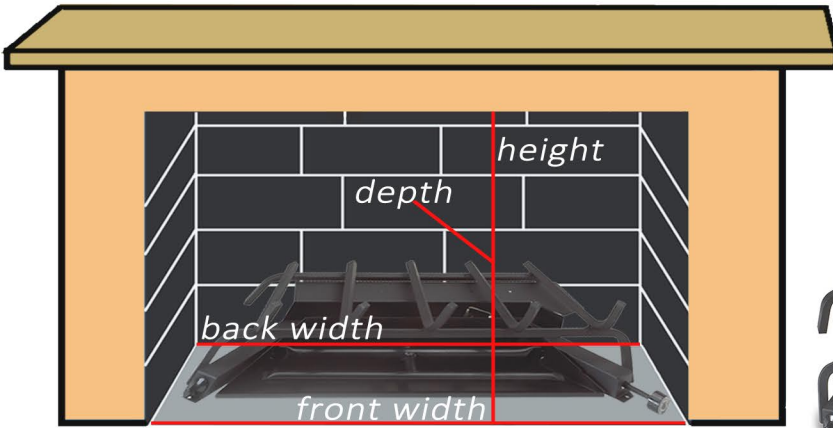

For Proper Installation
Measure the dimensions of firebox.
Width - Bottom of Firebox, Front & Back
Depth - Front to Back
Height - Bottom to Top



This patented system features hidden installed controls, piezo ignition and lively flames and embers with less BTUs.

Model	Minimum Fireplace Size				BTU Rating	
	Width*		Depth‡	Height	Nat. Gas	L.P. Gas
	Front	Rear†				
G46-18/20	26"	20"	15"	17"	40K	40K
G46-24	30"	24"	15"	17"	55K	55K
G46-30	36"	28"	15"	17"	65K	65K

* These required widths allow for centering of the unit.
For 02 models, add 2" to both front and rear width.
† Rear width is at corresponding depth.
‡ If an ash lip exist, the depth requirement begins inside of the lip.

Premium Gas Logs	18"	24"	30"	Burner Kit	18/20"	24"	30"
Split Oak	\$374	\$437	\$578	G46**	\$711	\$746	\$788
Charred Oak	\$431	\$506	\$676	G46**17	\$1,066	\$1,101	\$1,143
Charred American Oak	\$534	\$609	\$793	G46**02	\$1,357	\$1,392	\$1,434

Questions?

Contact your AES Sales Staff: (800) 682-9722

March 2024 Pricing



realfyre PREMIUM GAS LOGS

Manufacturing the highest quality gas logs for 75 years

Burnt Aspen



BTA**

Colonial Oak



COLO**

Charred
Evergreen Split Oak



ENS**

Charred
Evergreen Oak



ENO**

- Handcrafted Logs
- Clean Burning
- Naturally Detailed
- Unmatched Beauty
- Convenient
- Meticulously Crafted
- Enticing Dancing Flames
- Warmth & Ambiance
- Intricate Bark Detail

Questions?

Contact your AES Sales Staff: (800) 682-9722

AES

realfyre G52 BURNER

Choose Your Burner - Choose Your Log Set

G52**

- G52 Match Lit Burner with No Valve, Natural Gas Only
- Sizes: 18"/20" - 24"/30"

G52**17

- G52 Burner System with "17" Series Valve & Variable Remote
- Propane Option: G52**17P
- Sizes: 18"/20" - 24"/30"

G52**02

- G52 Burner System with "02" Electronic Valve & On/Off Remote
- Propane Option: G52**02P
- Sizes: 18"/20" - 24"/30"

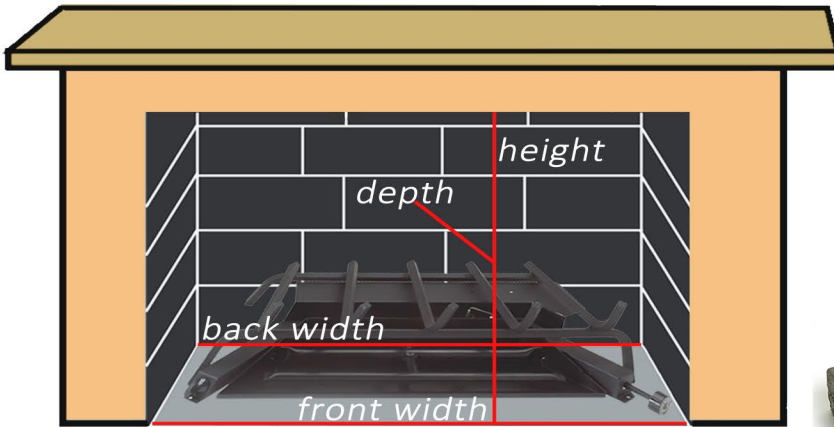

For Proper Installation
 Measure the dimensions of firebox.
 Width - Bottom of Firebox, Front & Back
 Depth - Front to Back
 Height - Bottom to Top

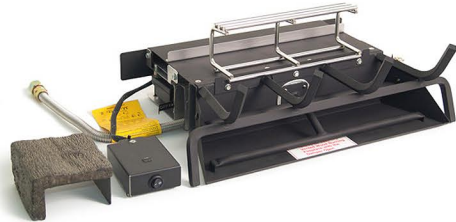

The burner system features an Exclusive stainless steel "booster grid" that acts as a catalyst to increase the intensity of the fire.

Model	Minimum Fireplace Size				BTU Rating			
	Width*		Depth‡	Height	Nat. Gas		L.P. Gas	
	Front	Rear†			High Setting	Low Setting▲	High Setting	Low Setting▲
G52-18/20 (18" log set)	26"	20"	15"	17"	46K	33K	36K	27K
G52-24/30 (24" log set)	32"	24"	15"	17"	55K	37K	46K	26K
G52-24/30 (30" log set)	34"	28"	15"	17"	55K	37K	46K	26K

* These required widths allow for centering of the unit. For 02 models, add 2" to both front and rear width.
 † Rear width is at corresponding depth.
 ‡ If an ash lip exist, the depth requirement begins inside of the lip.
 ▲ 2VT models only (not shown).

Premium Gas Logs	18"	24"	30"	Burner Kit	18/20"	24/30"
Colonial Oak	\$553	\$606	\$723	G52**	\$866	\$938
Charred Evergreen Oak	\$577	\$637	\$761	G52**17	\$1,569	\$1,641
Charred Evergreen Split Oak	\$603	\$673	\$804	G52**02	\$1,858	\$1,930
Burnt Aspen	\$616	\$683	\$816			

Questions?

Contact your AES Sales Staff: (800) 682-9722

March 2024 Pricing



Gas Logs

To use this Price Sheet -



1. Select log style design or contemporary media



Purchase Info. Key

- For all model numbers: **= Insert Size
- All prices: \$
- Weight: #

GAS LOG STYLE CODES

CHARRED SERIES	
CHD:	Charred Oak
HCHR:	Burnt Rustic Oak
CHS:	Charred Split
CHRRSO:	Charred Rugged Split Oak
CHAO:	Charred American Oak
CHN:	Charred Northern Oak
CHB:	Charred Royal English Oak
CHMJ:	Charred Majestic Oak
CHNA:	Charred Angel Oak
CHNS:	Charred Angel Split Oak
CHMBW:	Charred Mountain Birch
ENO:	Charred Evergreen Oak*
ENS:	Charred Evergreen Split Oak*
BTA:	Burnt Aspen*

DESIGNER SERIES	
RDP:	Golden Oak Designer Plus
HRD:	Rustic Oak Designer
AO:	American Oak
S:	Split Oak
SDP:	Split Oak Designer Plus
RRSO:	Rugged Split Oak
WO:	Woodland Oak
MBW:	Mountain Birch
W:	White Birch
BD:	Royal English Oak Designer
GSO:	Gnarled Split Oak
CN:	Chestnut Oak
RFS:	Rugged Forest Split
MCO:	Mountain Crest Oak*
MCS:	Mountain Crest Split Oak*
COLO:	Colonial Oak*

CLASSIC SERIES	
R:	Golden Oak
HR:	Rustic Oak
RRO:	Rugged Oak
PO:	Post Oak
B:	Royal English Oak
CDR:	Coastal Driftwood

See page 8 for See-thru Gas Log Sets

CONTEMPORARY MEDIA CODES

FYRE GLASS	
GL-F:	Azuria
GL-B:	Black
GL-Z:	Bronze
GL-N:	Caribbean Blue
GL-C:	Clear
GL-E:	Emerald
GL-W:	Star Fyre

FYRE GEMS	
GLG-J:	Black Pearl
GLG-T:	Blue Topaz
GLG-D:	Champagne
GLG-A:	Deep Amber
GLG-E:	Emerald
GLG-C:	Glacier
GLG-S:	Sapphire
GLG-RY:	Ruby

REFLECTIVE FYRE GLASS	
GL-FR:	Azuria Reflective
GL-BR:	Black Reflective
GL-ZR:	Bronze Reflective
GL-NR:	Caribbean Blue Reflective
GL-QR:	Copper Reflective
GL-ER:	Emerald Reflective
GL-HR:	Gold Reflective
GL-CR:	Champagne Reflective

DIAMOND NUGGETS	
GLD-C:	Clear
GLD-SB:	Steel Blue
GLD-R:	Rosé
GLD-E:	Emerald
GLD-PB:	Pacific Blue
GLD-DB:	Deep Black

FOR P45 BURNER	
EB:	Epic Black Fyre Spheres*
GS:	Graystone Fyre Spheres*
SO:	Shoreline Designer Oak*
SDW:	Shoreline Driftwood*

See Pages 14 & 15 for FYRE SPHERES & RIVER ROCK

* Log sets are only compatible with specific specialty burners - see Section V.

2. Select burner system



G45-24-02

BURNER STYLE CODES

LISTED BURNERS	
G4:	Glowing Ember
G45:	Triple T Burner
GX45:	Heavy Duty Triple T Burner
G45-GL:	Triple T Glass Burner
PB:	Pan Burner (For Glass)

ANSI CERTIFIED BURNERS	
G45(A):	Triple T Burner
G45(A)-SS:	Triple T Stainless Steel
G45-GL(A):	Triple T Glass Burner
G45-GL-SS:	Triple T Stainless Steel
G46:	Glowing Ember
PB(A):	Pan Burner (For Glass)
P45:	Tapered Pan Burner
G31:	3-Tiered Burner
G52:	Radiant Fyre Burner
G52-SS:	Radiant Fyre Burner Stainless Steel

See pages 8 - 9 for See-thru Burner Systems

3. Select size

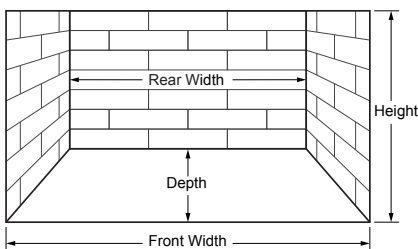

4. Select controls

(Page 13)



APK-15

5. Select accessories

(Pages 15-16)



DP-7 DECOR PACK
Featuring Bryte Coals

Gas Logs

I Standard Vented Gas Logs Only



B. Designer Series - Standard Gas Log Sets

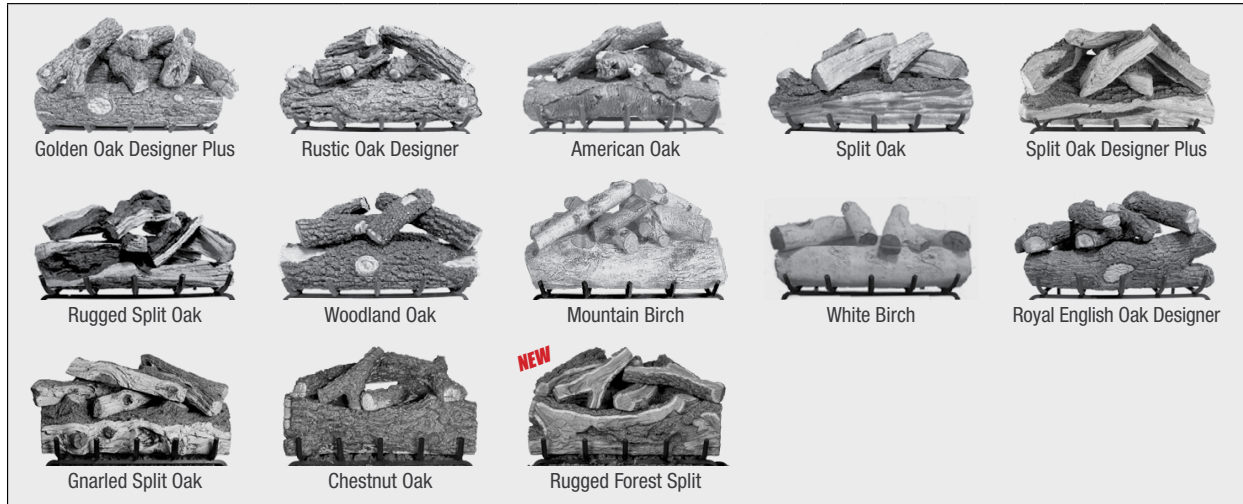

GAS LOG STYLE	BURNER KEY	MODEL #	12"	16"	18"	20"	24"	30"	36"*	42"*	48"*	60"*
Golden Oak Designer Plus	1	RDP-**	\$275 18#/1	\$297 26#/1	\$351 41#/1	\$374 46#/1	\$431 61#/1	\$581 75#/1	\$802 120#/2	\$1,009 187#/3	\$1,230 222#/3	\$1,482 299#/3
Rustic Oak Designer	1	HRD-**	--	298 26#/1	344 41#/1	--	417 61#/1	553 91#/1	806 128#/2	1,013 187#/3	--	--
American Oak	1	AO-**	--	--	474 49#/1	--	548 58#/1	695 77#/2	--	--	--	--
Split Oak	1	S-**	--	--	374 44#/1	397 48#/1	437 65#/1	578 78#/1	--	--	--	--
Split Oak Designer Plus	1	SDP-**	--	--	422 46#/1	457 49#/1	497 67#/1	645 78#/1	850 127#/2	--	--	--
Rugged Split Oak	1	RRSO-**	--	--	457 48#/1	--	521 61#/1	637 65#/1	--	--	--	--
Woodland Oak	1	WO-**	--	--	343 45#/1	354 46#/1	398 60#/1	516 86#/1	--	--	--	--
Mountain Birch	1	MBW-**	--	--	455 45#/1	--	516 72#/1	625 85#/1	850 115#/2	1,086 175#/3	--	--
White Birch	1	W-**	--	--	392 38#/1	--	438 60#/1	537 89#/1	--	--	--	--
Royal English Oak Designer *	2	BD-**	--	--	481 49#/1	--	577 87#/2	726 126#/2	923 152#/3	1,156 184#/3	--	--
Gnarled Split Oak	1	GSO-**	--	--	--	--	693 60#/1	879 95#/2	1,088 130#/3	--	--	--
Chestnut Oak	1	CN-**	--	--	484 43#/1	--	581 66#/1	752 104#/2	951 152#/3	--	--	--
NEW Rugged Forest Split	1	RFS-**	--	--	479 48#/1	--	551 68#/1	709 95#/2	901 146#/3	--	--	--

*Log set uses **GX45** Burner Kit with Heavy Duty Grate.

BURNER SYSTEM COMPATIBILITY KEY

The following numbers in the Log Style box designate the type of burners that are compatible with each Log Style.

- 1** Compatible with All Gas Log Burner Styles listed on pages 5 - 7 (Listed & ANSI CERTIFIED)
- 2** Compatible with G4, GX4, G45, GX45 and "P" Series Burner Systems (Listed Burners Only)
- 3** Compatible with G31 3-tiered Burner System (See page 11)

Stock: Y = Stock, N or * = Non-Stock, LTSD = Limited to Stock on Hand

Non-Stock Item Notice: Items marked non-stock must be ordered in case quantities

Gas Logs

I Standard Vented Gas Logs Only  2024

C. Classic Series - Standard Gas Log Sets



GAS LOG STYLE	BURNER KEY	MODEL #	12"	16"	18"	20"	24"	30"	36"*	42"*
Golden Oak	1	R-**	\$190 18#/1	\$204 26#/1	\$226 41#/1	\$237 45#/1	\$252 58#/1	\$316 89#/1	\$491 120#/2	\$731 187#/3
Rustic Oak	1	HR-**	--	205 26#/1	227 41#/1	--	253 58#/1	317 94#/1	493 128#/2	735 187#/3
Rugged Oak	1	RRO-**	--	--	283 48#/1	--	339 61#/1	418 68#/1	--	--
Post Oak	1	PO-**	--	--	212 45#/1	224 46#/1	241 60#/1	303 86#/1	--	--
Royal English Oak *	2	B-**	--	--	307 49#/1	--	382 87#/2	473 126#/2	608 152#/3	809 184#/3
Coastal Driftwood	2	CDR-**	--	--	256 44#/1	--	287 56#/1	352 57#/1	501 81#/2	--

*Log set uses **GX4** or **GX45** Burner Kit with Heavy Duty Grate.

II Standard Vented Burners Only  2024

A. G4 Series Listed Burner Systems



DESCRIPTION	MODEL #	12"	16"	18/20"	24"	30"
Glowing Ember Burner System	G4-**	\$261 23#	\$281 24#	\$288 25#	\$303 29#	\$356 35#

Shipped for use with Natural Gas - Specify if for Propane Gas by adding a "P" to the model number (e.g. G4-24P), and add \$222 for required **SPK-26**.

B. G45 Series Listed Burner Systems - Standard & Glass



DESCRIPTION	MODEL #	16"	18/20"	24"	30"	36"*	42"*	48"*	60"*
Triple T Burner System	G45-**	\$327 25#	\$338 27#	\$366 31#	\$429 37#	\$587 54#	\$827 82#	\$907 97#	\$985 120#
Triple T Burner System (with Heavy Duty Grate)	GX45-**	--	374 31#	403 36#	472 43#	--	--	--	--
Triple T Burner System (for use with Glass Media) †	G45-GL-**	304 20#	314 22#	337 23#	412 31#	553 45#	922 70#	865 80#	941 100#

Shipped for use with Natural Gas - Specify if for Propane Gas by adding a "P" to the model number (e.g. G45-24P), and add \$222 for required **SPK-26**.

G4 & G45 Burner Systems are Listed up to 30" and include:

Burner, Custom Grate, Glowing Embers, Sand (NG) or Vermiculite (LP), Burner Stabilizing Clips, Flex Connector Kit, & Damper Clamp.

* (-GL) Burners include Stainless Glass Screen and **Do Not** Include Custom Grate or Glowing Embers. † See page 14 for Glass Media options.

2
0
2
5
-
2
0
2
6

Gas Logs

II Standard Vented Burners Only  **2024**

C. G45 Series Triple T Outdoor Burner Systems (-02 Valve) - with S.S. Burner Pan

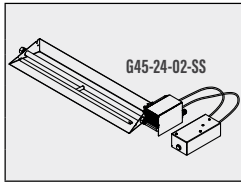

DESCRIPTION	MODEL #	16"	18/20"	24"	30"	36"*	42"***	48"***	60"***
Assembled G45 Outdoor Burner System with "02" Electronic Safety Valve & Remote	G45-**-02-SS	\$1,434 28#	\$1,457 31#	\$1,488 35#	\$1,565 41#	\$1,736 56#	--	--	--
	G45-GL-**-02-SS (for Glass Media)†	1,411 23#	1,433 26#	1,460 27#	1,532 35#	1,701 45#	--	--	--

Shipped for use with Natural Gas - Specify if for Propane gas by adding a "P" to the model number (e.g. G45-24-02P-SS).
Remote systems include basic Transmitter and Receiver.

*Burner includes Heavy Duty Grate (36" and larger).

D. G45 Series ANSI Certified Triple T Burner Systems - Standard & Glass

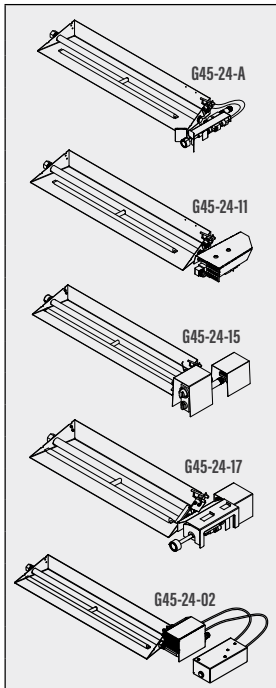

DESCRIPTION	MODEL #	16"	18/20"	24"	30"	36"*
Assembled G45 Burner System with Safety Valve	G45-**-A	\$677 26#	\$687 28#	\$716 32#	\$783 38#	\$942 58#
	G45-GL-**-A (for Glass Media)†	654 21#	663 23#	686 24#	749 32#	907 47#
Assembled G45 Burner System with "11" Series Safety Valve & ON/OFF Remote	G45-**-11	1,113 27#	1,123 29#	1,152 33#	1,219 39#	1,378 54#
	G45-GL-**-11 (for Glass Media)†	1,090 22#	1,099 24#	1,122 25#	1,185 33#	1,343 43#
Assembled G45 Burner System with "15" Series Safety Valve & Variable Remote	G45-**-15	1,184 27#	1,194 29#	1,223 33#	1,290 39#	1,449 54#
	G45-GL-**-15 (for Glass Media)†	1,161 22#	1,170 24#	1,193 25#	1,256 33#	1,414 43#
Assembled G45 Burner System with "17" Series Safety Valve & Variable Remote	G45-**-17	1,021 27#	1,031 29#	1,060 33#	1,127 39#	1,286 54#
	G45-GL-**-17 (for Glass Media)†	998 22#	1,007 24#	1,030 25#	1,093 33#	1,251 43#
Assembled G45 Burner System with "02" Electronic Safety Valve & Remote	G45-**-02	1,341 28#	1,351 31#	1,380 35#	1,447 41#	1,606 56#
	G45-GL-**-02 (for Glass Media)†	1,318 23#	1,327 26#	1,350 27#	1,413 35#	1,571 45#

Shipped for use with Natural Gas - Specify if for Propane Gas by adding a "P" to the model number (e.g. G45-24-11P).

*Burner includes Heavy Duty Grate.

E. G45 Series ANSI Certified Triple T Outdoor Burner Systems - with S.S. Burner Pan



DESCRIPTION	MODEL #	16"	18/20"	24"	30"	36"*	42"***	48"***	60"***
Outdoor Triple T Burner System (Nat. Gas only)	G45-**-SS	\$416 25#	\$439 27#	\$470 31#	\$541 37#	\$704 56#	\$946 87#	\$1,032 97#	\$1,125 120#
	G45-GL-**-SS (for Glass Media)†	394 20#	415 22#	441 23#	510 31#	671 45#	907 70#	989 80#	1,083 100#
Assembled G45 Outdoor Burner System with Safety Valve	G45-**-NA-SS	789 26#	812 28#	843 32#	914 38#	1,077 58#	1,319 89#	1,405 99#	1,498 122#
	G45-GL-**-NA-SS (for Glass Media)†	767 21#	788 23#	814 24#	883 32#	1,044 47#	1,280 72#	1,362 82#	1,456 102#

Shipped for use with Natural Gas - Specify if for propane gas by adding a "P" to the model number (e.g. G45-24-PA-SS).

*Burner includes Heavy Duty Grate (36" and larger).

Stock: Y = Stock, N or * = Non-Stock, LTSD = Limited to Stock on Hand

Non-Stock Item Notice: Items marked non-stock must be ordered in case quantities

Standard Vented Burners Only  2024

2
0
2
5
-
2
0
2
6

F. G46 Series ANSI Certified Burner Systems

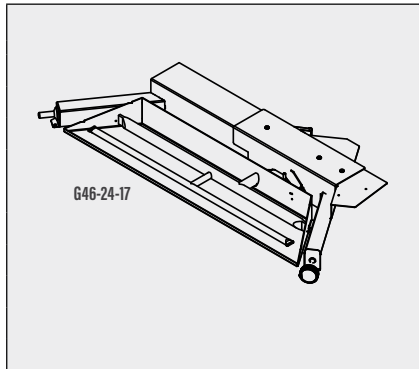

DESCRIPTION	MODEL #	18/20"	24"	30"
G46 Burner System with Safety Pilot Kit	G46-**-	\$711 20#	\$746 23#	\$788 28#
G46 Burner System with "11" Series Valve & ON/OFF Remote	G46-**-11	1,161 21#	1,196 24#	1,238 28#
G46 Burner System with "15" Series Valve & Variable Remote	G46-**-15	1,233 21#	1,268 24#	1,310 28#
G46 Burner System with "17" Series Valve & Variable Remote	G46-**-17	1,066 21#	1,101 24#	1,143 28#
G46 Burner System with "02" Electronic Valve & Remote	G46-**-02	1,357 21#	1,392 24#	1,434 28#

G46 ANSI Certified Burner Systems include: ANSI Certified Burner with Pre-assembled Control Valve & Regulator, Piezo Igniter, Custom Grate, Glowing Embers, Sand (NG) or Vermiculite (LP), Connector Kit, Log Locators, & Damper Clamp. Remote systems include basic Transmitter and Receiver.

Shipped for use with Natural Gas. Specify if for Propane Gas by adding a "P" to the model number (e.g. G46-24-11P).

G. PB Series Listed Flame Pan Burner Systems

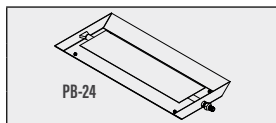

DESCRIPTION	MODEL #	16"	18"	20"	24"	30"	36"	42"
Glass Pan Burner System †	PB-**-	\$267 20#	\$277 22#	\$282 24#	\$287 28#	\$337 35#	\$482 40#	\$703 45#

PB Series Glass Burner Systems Include: Pan Burner Assembly, Connector Kit, Sand (NG) or Vermiculite (LP), and Damper Clamp.

Shipped for use with Natural Gas - Specify if for Propane Gas by adding a "P" to the model number (e.g. PB-24P), and add \$222 for required SPK-26.

Log Kit = For using logs on PB burners, includes log rests and legs. Part #: **PB-LEG-KIT**; Price: **\$133**.

H. PB Series ANSI Certified Flame Pan Glass Burner System

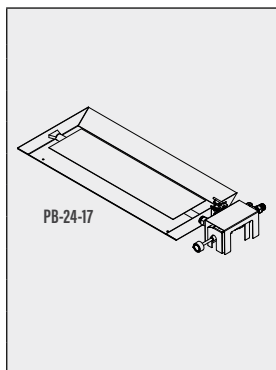

DESCRIPTION	MODEL #	18/20"	24"	30"
Assembled Glass Pan Burner with Safety Valve †	PB-**-A	\$624 25#	\$637 31#	\$686 38#
Assembled Glass Pan Burner with "11" Series Valve & ON/OFF Remote †	PB-**-11	1,059 29#	1,072 34#	1,121 41#
Assembled Glass Pan Burner with "15" Series Valve & Variable Remote †	PB-**-15	1,131 29#	1,144 34#	1,193 41#
Assembled Glass Pan Burner with "17" Series Valve & Variable Remote †	PB-**-17	969 27#	982 32#	1,031 39#
Assembled Glass Pan Burner with "02" Electronic Valve & Remote †	PB-**-02	1,285 29#	1,298 34#	1,347 41#

Shipped for use with Natural Gas - Specify if for Propane Gas by adding a "P" to the model number (e.g. PB-24-11P).

Gas Logs

III See-Thru Log Sets Only



A. Charred Series • See-Thru Gas Log Sets

DESCRIPTION	MODEL #	16"	18/20"	20"	24"	30"	36"	42"	48"	60"
Charred Oak	CHD-2-**	\$458 30#/1	\$516 48#/1	--	\$602 62#/1	\$780 84#/1	--	--	--	--
Charred Rugged Split Oak	CHRRSO-2-**	--	573 48#/1	--	677 59#/1	834 74#/1	--	--	--	--
Charred American Oak	CHAO-2-**	--	623 62#/1	--	723 77#/1	912 95#/2	--	--	--	--
Charred Royal English Oak <small>(uses GX45-2-** burner w/ heavy duty grate)</small>	CHB-2-**	--	643 52#/1	--	743 83#/2	930 111#/2	1,145 141#/3	1,486 169#/3	--	--

B. Designer Series • See-Thru Gas Log Sets

DESCRIPTION	MODEL #	16"	18"	20"	24"	30"	36"	42"	48"	60"
Golden Oak Designer Plus	RDP-2-**	\$336 24#/1	\$398 46#/1	\$425 49#/1	\$519 71#/1	\$672 86#/1	\$960 137#/3	\$1,042 194#/3	\$1,311 229#/3	\$1,533 305#/3
American Oak	AO-2-**	--	534 55#/1	--	623 62#/1	791 85#/2	--	--	--	--
Split Oak Designer Plus	SDP-2-**	--	491 46#/1	523 49#/1	578 70#/1	746 83#/1	1,004 129#/3	--	--	--
Rugged Split Oak	RRSO-2-**	--	521 53#/1	--	595 67#/1	723 76#/1	--	--	--	--
Mountain Birch	MBW-2-**	--	529 53#/1	--	578 80#/1	703 91#/1	--	--	--	--

C. Classic Series • See-Thru Gas Log Sets

DESCRIPTION	MODEL #	16"	18"	20"	24"	30"	36"	42"	48"	60"
Golden Oak	R-2-**	\$238 27#/1	\$260 46#/1	\$276 48#/1	\$293 68#/1	\$370 97#/1	\$583 137#/3	\$834 194#/3	--	--
Coastal Driftwood	CDR-2-**	--	304 46#/1	--	333 65#/1	418 75#/1	623 100#/3	--	--	--

IV See-Thru Burners Only



A. G45 Series See-Thru Listed Triple T Burner Systems - Standard & Glass

DESCRIPTION	MODEL #	16"	18/20"	24"	30"	36"*	42"*	48"*	60"*
Triple T Burner System	G45-2-**	\$393 40#	\$408 43#	\$441 50#	\$513 61#	\$778 82#	\$1,038 90#	\$1,123 105#	\$1,258 140#
Triple T Burner System <small>(with Heavy Duty Grate)</small>	GX45-2-**	--	465 43#	506 61#	588 79#	--	--	--	--
Triple T Burner System †	G45-2-GL-**	368 35#	383 38#	409 41#	478 53#	743 70#	997 80#	1,077 95#	1,211 120#

Shipped for use with Natural Gas - Specify if for Propane Gas by adding a "P" to the model number (e.g. G45-2-24P), and add \$222 for required SPK-26.

* Burner includes Heavy Duty Grate (36" and larger).

Stock: Y = Stock, N or * = Non-Stock, LTSD = Limited to Stock on Hand

Non-Stock Item Notice: Items marked non-stock must be ordered in case quantities

Gas Logs

IV See-Thru Burners Only



2024

2
0
2
5
-
2
0
2
6

B. G45 See-Thru Triple T Outdoor Burner Systems (-02 Valve) - w/ S.S. Burner Pan

DESCRIPTION	MODEL #	16"	18/20"	24"	30"	36"*	42"***	48"***	60"***
Assembled G45 Outdoor Burner w/ "02" Series Electronic Valve & Remote	G45-2-**-02-SS	\$1,512 44#	\$1,552 47#	\$1,602 54#	\$1,685 65#	\$1,969 86#	--	--	--
	G45-2-GL-**-02-SS (for Glass Media) †	1,487 39#	1,525 42#	1,570 45#	1,650 55#	1,935 74#	--	--	--

Shipped for use with Natural Gas - Specify if for propane gas by adding a "P" to the model number (e.g. G45-2-24-02P-SS).

Remote systems include basic Transmitter and Receiver.

* Burner includes Heavy Duty Grate (36" and larger).

C. G45 Series See-Thru ANSI Certified Triple T Burner Systems - Standard & Glass

DESCRIPTION	MODEL #	16"	18/20"	24"	30"	36"*	42"*	48"*	60"*
Assembled G45 Burner with Safety Valve	G45-2-**-A	\$742 42#	\$759 45#	\$789 52#	\$864 63#	\$1,132 84#	--	--	--
	G45-2-GL-**-A (for Glass Media) †	717 37#	733 40#	760 43#	829 53#	1,097 72#	--	--	--
Assembled G45 Burner w/ "11" Series Valve & ON/OFF Remote	G45-2-**-11	1,181 42#	1,198 45#	1,228 52#	1,303 63#	1,571 84#	--	--	--
	G45-2-GL-**-11 (for Glass Media) †	1,156 37#	1,172 40#	1,199 43#	1,268 53#	1,536 72#	--	--	--
Assembled G45 Burner w/ "15" Series Valve & Variable Remote	G45-2-**-15	1,253 42#	1,270 45#	1,300 52#	1,375 63#	1,643 84#	--	--	--
	G45-2-GL-**-15 (for Glass Media) †	1,228 37#	1,244 40#	1,271 43#	1,340 53#	1,608 72#	--	--	--
Assembled G45 Burner w/ "17" Series Valve & Variable Remote	G45-2-**-17	1,090 42#	1,107 45#	1,137 52#	1,212 63#	1,480 84#	--	--	--
	G45-2-GL-**-17 (for Glass Media) †	1,065 37#	1,081 40#	1,108 43#	1,177 53#	1,445 72#	--	--	--
Assembled G45 Burner w/ "02" Series Electronic Valve & Remote	G45-2-**-02	1,413 44#	1,430 47#	1,460 54#	1,535 65#	1,803 86#	--	--	--
	G45-2-GL-**-02 (for Glass Media) †	1,388 39#	1,404 42#	1,431 45#	1,500 55#	1,768 74#	--	--	--

Shipped for use with Natural Gas - Specify if for Propane Gas by adding a "P" to the model number (e.g. G45-2-24-11P).

Remote systems include basic Transmitter and Receiver.

* Burner includes Heavy Duty Grate (36" and larger).

D. G45 See-Thru ANSI Certified Triple T Outdoor Burner Systems - w/ S.S. Burner Pan

DESCRIPTION	MODEL #	16"	18/20"	24"	30"	36"*	42"***	48"***	60"***
Outdoor Triple T Burner System w/ Stainless Steel Burner Pan (Natural Gas only)	G45-2-**-SS	\$488 40#	\$524 45#	\$571 59#	\$651 75#	\$924 82#	\$1,190 90#	\$1,284 105#	\$1,437 140#
	G45-2-GL-**-SS (for Glass Media) †	464 35#	499 40#	541 50#	618 65#	890 70#	1,148 80#	1,239 95#	1,392 120#
Assembled G45 Outdoor Burner with Safety Valve	G45-2-**-NA-SS	866 42#	902 45#	949 52#	1,029 63#	1,302 84#	1,568 92#	1,662 107#	1,815 142#
	G45-2-GL-**-NA-SS (for Glass Media) †	842 37#	877 40#	919 43#	996 53#	1,268 72#	1,526 82#	1,617 97#	1,770 122#

Shipped for use with Natural Gas - Specify if for propane gas by adding a "P" to the model number (e.g. G45-2-24-PA-SS).

* Burner includes Heavy Duty Grate (36" and larger).

† Sizes 42" - 60" are not certified & are not regulated

Associated Energy Systems - Serving you with distribution centers in: Kent, WA | West Sacramento, CA | Denver, CO | Dallas, TX | Rogers, MN

V Specialty Burner Systems & Gas Logs



G31 3-Tiered Burner System & Mountain Crest Style Logs

- Featuring specially designed, hand-crafted **Mountain Crest Oak** & **Mountain Crest Split Oak** Logs.
- **G31 Burner System Includes:** Advanced 3-tiered burner • Porcelainized Reflective Front Panel • Custom grate • Bryte Coals • Glowing Embers • Sand (NG) or Vermiculite (LP) • Connector Kit & Damper Clamp • Choice of pre-assembled Electronic Remote Control, Automatic Variable Control with Remote, pre-assembled Manual Pilot Kit, or Match-Lit System (Natural Gas only).

A. Mountain Crest Gas Logs Only

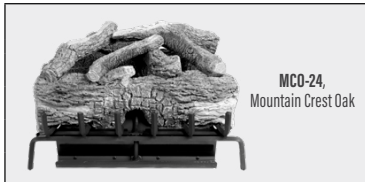

DESCRIPTION	MODEL #	18"	24"	30"	33"	39"
Mountain Crest Oak	MCO-**	\$450 44#	\$510 52#	\$593 56#	\$648 62#	\$734 68#
Mountain Crest Split Oak	MCS-**	468 42#	533 50#	618 54#	675 60#	763 66#

See page 3 for additional gas log sets compatible with the G31 Burner System (**Burner Key "3"**).

B. G31 3-Tiered Burner System Only



DESCRIPTION	MODEL #	18/20"	24/30"	33/39"
G31 Burner, Match Lit without Valve <i>(Natural Gas only)</i>	G31-**	\$1,247 38#	\$1,302 44#	\$1,472 48#
G31 Burner with Manual Valve and Standing Pilot *	G31-**-A	1,597 40#	1,652 46#	1,822 50#
G31 Burner with Automatic Variable Valve and Remote *	G31-**-17	1,950 40#	2,005 46#	2,175 50#
G31 Burner with Electronic Valve and on/off Remote *	G31-**-02	2,239 42#	2,294 48#	2,464 52#
G31 Burner with Electronic Variable Valve and Remote *	G31-**-2VT	2,261 42#	2,316 48#	2,486 52#

* Shipped for use with Natural Gas - Specify if for Propane Gas by adding a "P" to the model number (e.g. G31-24/30-02P).

V Specialty Burner Systems & Gas Logs



G52 Radiant Fyre System & Fiber Enhanced Ceramic Logs

- Featuring specially formulated, hand-crafted **Charred Evergreen Oak, Charred Evergreen Split Oak, Colonial Oak, & Burnt Aspen Logs.**
- **Burner System Includes:** Advanced Radiant Fyre Burner • Exclusive radiant stainless steel booster grid • Custom grate • Platinum Embers • Glowing Embers • Sand (NG) or Vermiculite (LP) • Connector Kit & Damper Clamp • Choice of pre-assembled Electronic Remote Control, Automatic Variable Control with Remote, pre-assembled Manual Pilot Kit, or Match-Lit System (Natural Gas only).

C. Fiber Enhanced Ceramic Gas Logs Only

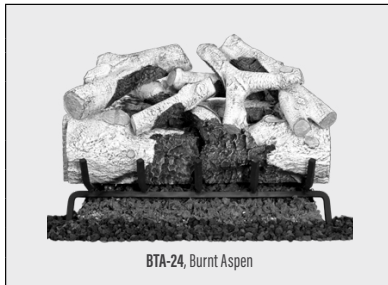

DESCRIPTION	MODEL #	18"	24"	30"
Charred Evergreen Oak	ENO-**	\$577 36#	\$637 48#	\$761 58#
Charred Evergreen Split Oak	ENS-**	603 36#	673 48#	804 58#
Colonial Oak	COLO-**	553 36#	606 48#	723 58#
Burnt Aspen	BTA-**	616 36#	683 48#	816 58#

D. G52 Radiant Fyre Burner System Only



DESCRIPTION	MODEL #	18/20"	24/30"
G52 Burner, Match Lit without Valve <i>(Natural Gas only)</i>	G52-**	\$866 34#	\$938 38#
G52 Burner with Manual Valve and Standing Pilot *	G52-**-A	1,216 37#	1,288 41#
G52 Burner with Automatic Variable Valve and Remote *	G52-**-17	1,569 37#	1,641 41#
G52 Burner with Electronic Valve and on/off Remote *	G52-**-02	1,858 38#	1,930 42#
G52 Burner with Electronic Variable Valve and Remote *	G52-**-2VT	1,883 38#	1,955 42#

* Shipped for use with Natural Gas - Specify if for Propane Gas by adding a "P" to the model number (e.g. G52-24/30-17P).

E. G52 Radiant Fyre Burner Outdoor System Only (Stainless Steel)



DESCRIPTION	MODEL #	18/20"	24/30"
G52 Outdoor Burner, Match Lit without Valve <i>(Natural Gas only)</i>	G52-**-SS	\$1,120 34#	\$1,223 38#
G52 Outdoor Burner with Manual Valve and Standing Pilot *	G52-**-NA-SS	1,491 37#	1,594 41#

* Shipped for use with Natural Gas - Specify if for Propane Gas by adding a "P" to the model number (e.g. G52-24/30-NA-P-SS).

2
0
2
5
-
2
0
2
6

V Specialty Burner Systems & Gas Logs



P45 Pan Burner, Compatible Logs, & Fyre Spheres

- Featuring specially formulated, hand-crafted **Charred Evergreen Oak, Charred Evergreen Split Oak, Colonial Oak, & Burnt Aspen Logs.**
- **P45 Series Burner Systems Include:** Certified Pan Burner with Pre-assembled Control Valve & Regulator, Burner Legs, Vermiculite, Connector Kit and Damper Clamp.

F. P45 Gas Log Sets Only



DESCRIPTION	MODEL #	18"	24"	30"
Shoreline Designer Oak	SO-**	\$374 10 pcs.	\$423 12 pcs.	\$544 15 pcs.
Shoreline Driftwood	SDW-**	265 9 pcs.	299 11 pcs.	396 13 pcs.

G. P45 Fyre Spheres Only

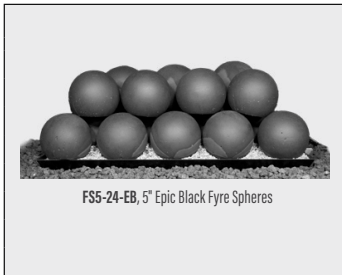

DESCRIPTION	MODEL #	18"	24"	30"
4" Epic Black Fyre Spheres	FS4-**-EB	\$280 19 pcs.	\$353 24 pcs.	\$500 34 pcs.
4" Graystone Fyre Spheres	FS4-**-GS	252 19 pcs.	318 24 pcs.	452 34 pcs.
5" Epic Black Fyre Spheres	FS5-**-EB	310 14 pcs.	420 19 pcs.	529 24 pcs.
5" Graystone Fyre Spheres	FS5-**-GS	279 14 pcs.	377 19 pcs.	478 24 pcs.

NEW H. Mixed Select Fyre Sphere Sets Only



DESCRIPTION	MODEL #	18"	24"	30"
Epic Black Mixed Select Fyre Spheres Set	FSM-**-EB	\$223 (4) 4-Packs	\$316 (6) 4-Packs	\$483 (8) 4-Packs
Graystone Mixed Select Fyre Spheres Set	FSM-**-GS	204 (4) 4-Packs	290 (6) 4-Packs	441 (8) 4-Packs

<p>18" Sets Includes:</p> <ul style="list-style-type: none"> • (1) 4-Pk. of 2" Spheres • (1) 4-Pk. of 3" Spheres 	<p>24" Sets Includes:</p> <ul style="list-style-type: none"> • (1) 4-Pk. of 4" Spheres • (1) 4-Pk. of 5" Spheres 	<p>30" Sets Includes:</p> <ul style="list-style-type: none"> • (2) 4-Pk. of 2" Spheres • (1) 4-Pk. of 3" Spheres • (2) 4-Pk. of 4" Spheres • (1) 4-Pk. of 5" Spheres • (1) 4-Pk. of 6" Spheres
---	---	--

I. P45 Series ANSI Certified Standard & Glass Pan Burners

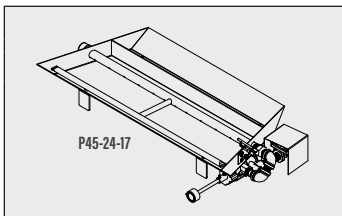

DESCRIPTION	MODEL #	18"	24"	30"
P45 Pan Burner Match Lit (Natural Gas Only) †	P45-**	\$335 23#	\$361 26#	\$405 31#
P45 Pan Burner with Manual Valve and Standing Pilot †	P45-**-A	642 25#	668 28#	712 33#
P45 Pan Burner with Automatic Variable Valve and Remote †	P45-**-17	986 25#	1,012 28#	1,056 33#

Shipped for use with Natural Gas - Specify if for Propane Gas by adding a "P" to the model number (e.g. P45-24-17P).

† Glass burners do not include grate or embers. For Glass Media Options see page 14.

Gas Logs

VI Safety Valves & Remote Compatible Options  2024

A. ON/OFF Bluetooth Control System

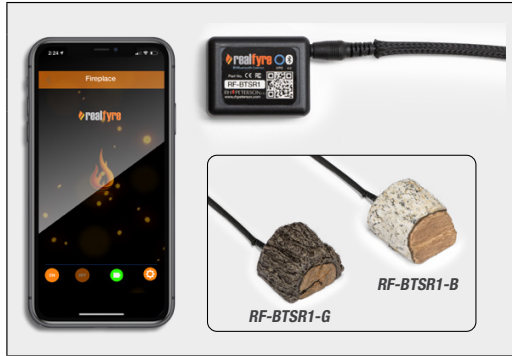

DESCRIPTION	MODEL #	PRICE
ON/OFF Bluetooth Control with Golden Oak Cover	RF-BTSR1-G	\$234
ON/OFF Bluetooth Control with White Birch Cover	RF-BTSR1-B	240

Burner System Compatibility			Control Valve Compatibility				
BURNER KITS	-02 Series	-11 Series	VALVES	-01 Series	-02 Series	-10 Series	-11 Series
G31	●	●	APK			●	●
G45	●	●	EPK	●	●		
G46	●	●	EPK-2M-AD		●		
G52	●	●					
PB	●	●					

B. Safety Control Valve Systems

DESCRIPTION	MODEL #	PRICE
Low Profile, Safety Pilot Kit with removable knob handle	SPK-26 *	\$218
High Capacity, Automatic Pilot Kit with basic transmitter & receiver	APK-10 *	894
Automatic Pilot Kit with basic transmitter & receiver	APK-11 *	646
Variable, Automatic Pilot Kit with basic transmitter & receiver	APK-15 (or APK-15P) ‡	716
Low Profile, Variable, Automatic Pilot Kit with basic transmitter & receiver	APK-17 *	566
Electronic Pilot Kit with on/off basic transmitter & receiver	EPK-2 (or EPK-2P) ‡	827
110 Volt Powered Electronic, non-standing pilot system designed to be installed outside the firebox	EPK-2M-AD (or EPK-2M-AD/LP) ‡	793
110 Volt Powered Electronic, non-standing pilot system with variable flame height control	EPK-2V-TR (or EPK-2VP-TR) ‡	1,030
High Capacity, 110 Volt Powered Electronic, non-standing pilot system w/variable flame height control	EPK-3V-TR (or EPK-3VP-TR) ‡	1,173
Manual On/Off Valve with knob handle	AV-17	79
Case of 12 - Manual On/Off Valves w/ knob handle	AV-17-12	935
Manual On/Off Valve with extension handle	AV-18	82
Case of 12 - Manual On/Off Valves w/ extension handle	AV-18-12	976
Straight Line Gas Valve with Key	AV-30	68

* = Field convertible Propane Orifice Included. Specify if for Propane by adding a "P" to the model number (e.g. **APK-17P**).

‡ = Not Field Convertible. Kit **Must** be ordered for specific gas (e.g. **APK-15** for Natural Gas or **APK-15P** for Propane).

C. Remote Compatible Options & Accessories



DESCRIPTION	MODEL #	PRICE
Basic ON/OFF Receiver/Transmitter Set	RR-1A	\$123
Deluxe ON/OFF Receiver/Transmitter Set	RR-2A	179
Basic Variable Receiver/Transmitter Set for "15" & "17" Style Models	VR-1A	149
Deluxe Variable Receiver/Transmitter Set for "15" & "17" Style Models	VR-2A	204
Wall Switch, Cover and Wiring	WS-1	71
Wall Timer, Cover and Wiring	WS-2	174
Wall Switch, Cover and Wiring ("15" & "17" Models Only)	WS-3	87

G4 & G45 Burner Size Compatibility for Safety Valves

VALVE MODEL	GAS TYPE	MAX BTU † INPUT	G4 & G45 STANDARD	G45-2 SEE-THRU
SPK-26	N.G.	100,000	12" - 36"	16" - 30"
SPK-26P	L.P.	200,000	12" - 60"	16" - 60"
APK-10	N.G.	230,000	12" - 60"	16" - 60"
APK-10P	L.P.	372,000	12" - 60"	16" - 60"
APK-11	N.G.	70,000	12" - 30"	16" - 18"
APK-11P	L.P.	110,000	12" - 42"	16" - 30"
APK-15	N.G.	85,000	12" - 30"	16" - 18"
APK-15P	L.P.	135,000	12" - 42"	16" - 36"
APK-17	N.G.	100,000	12" - 42"	16" - 30"
APK-17P	L.P.	200,000	12" - 60"	16" - 60"
EPK-2	N.G.	120,000	12" - 42"	16" - 30"
EPK-2P	L.P.	190,000	12" - 60"	16" - 60"
EPK-2M-AD	N.G.	120,000	12" - 30"	16" - 18"
EPK-2M-AD/LP	L.P.	190,000	12" - 42"	16" - 30"
EPK-2V-TR	N.G.	120,000	12" - 42"	16" - 30"
EPK-2VP-TR	L.P.	180,000	12" - 60"	16" - 60"
EPK-3V-TR	N.G.	200,000	12" - 60"	16" - 60"
EPK-3VP-TR	L.P.	320,000	12" - 60"	16" - 60"

† Using Real Fyre® Burner Systems

2
0
2
5
-
2
0
2
6

Gas Logs

***PLEASE NOTE: AES STOCKS 10LB ONLY**

VII Glass Media & Fyre Spheres



A. Fyre Glass

AVAILABLE COLORS	10 lb. Package	40 lb. Bucket
	\$103	\$414
Azuria	GL-10-F	GL-40-F
Black	GL-10-B	GL-40-B
Bronze	GL-10-Z	GL-40-Z
Caribbean Blue	GL-10-N	GL-40-N
Clear	GL-10-C	GL-40-C
Emerald	GL-10-E	GL-40-E
Star Fyre	GL-10-W	GL-40-W



B. Reflective Fyre Glass

AVAILABLE COLORS	10 lb. Package	40 lb. Bucket
	\$114	\$451
Azuria Reflective	GL-10-FR	GL-40-FR
Black Reflective	GL-10-BR	GL-40-BR
Bronze Reflective	GL-10-ZR	GL-40-ZR
Caribbean Blue Refl.	GL-10-NR	GL-40-NR
Copper Reflective	GL-10-OR	GL-40-OR
Emerald Reflective	GL-10-ER	GL-40-ER
Gold Reflective	GL-10-HR	GL-40-HR
Champagne Reflective	GL-10-CR	GL-40-CR



C. Fyre Gems

AVAILABLE COLORS	10 lb. Package	40 lb. Bucket
	\$87	\$343
Black Pearl	GLG-10-J	GLG-40-J
Blue Topaz	GLG-10-T	GLG-40-T
Champagne	GLG-10-D	GLG-40-D
Deep Amber	GLG-10-A	GLG-40-A
Emerald	GLG-10-E	GLG-40-E
Glacier	GLG-10-C	GLG-40-C
Sapphire	GLG-10-S	GLG-40-S
Ruby	GLG-10-RY	GLG-40-RY



D. Diamond Nuggets

AVAILABLE COLORS	10 lb. Package	40 lb. Bucket
	\$99	\$398
Clear	GLD-10-C	GLD-40-C
Steel Blue	GLD-10-SB	GLD-40-SB
Rosé	GLD-10-R	GLD-40-R
Emerald	GLD-10-E	GLD-40-E
Pacific Blue	GLD-10-PB	GLD-40-PB
Deep Black	GLD-10-DB	GLD-40-DB



E. Fyre Spheres

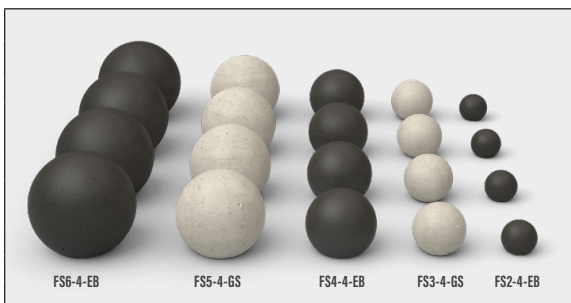

DESCRIPTION	COLOR	MODEL #	PRICE
2" Fyre Spheres (4 in a box)	Epic Black	FS2-4-EB	\$40
	Graystone	FS2-4-GS	37
3" Fyre Spheres (4 in a box)	Epic Black	FS3-4-EB	50
	Graystone	FS3-4-GS	46
4" Fyre Spheres (4 in a box)	Epic Black	FS4-4-EB	58
	Graystone	FS4-4-GS	53
5" Fyre Spheres (4 in a box)	Epic Black	FS5-4-EB	87
	Graystone	FS5-4-GS	79
6" Fyre Spheres (4 in a box)	Epic Black	FS6-4-EB	135
	Graystone	FS6-4-GS	122

VIII Accessories



NEW A. Flame Enhancer Kit (Compatible with G4 & G45 Burners)

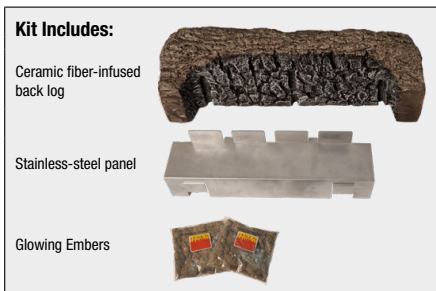

DESCRIPTION	MODEL #	PRICE
18" Flame Enhancer Kit	FE-18	\$192
24" Flame Enhancer Kit	FE-24	264
30" Flame Enhancer Kit	FE-30	287

LOG SET	SIZE COMPATIBILITY		
	FE-18	FE-24	FE-30
CHD-	18/20	24	30
CHAO-	18/20	24	30
CHS-	18/20	24	30
CHB-	18/20	24	30
HCHS-	18/20	24	30
HCHR-	18/20	24	30
PN-	--	24	30
CHMJ-	--	24	30
HRD-	18	24	30
AO-	18	24	30
S-	18, 20	24	30
WO-	18, 20	24	30
BD-	18	24	30
PO-	18, 20	24	30
HR-	18	24	--
B-	18	24	30

Stock: Y = Stock, N or * = Non-Stock, LTSD = Limited to Stock on Hand

Non-Stock Item Notice: Items marked non-stock must be ordered in case quantities

VIII Accessories



B. Three-Panel Fyrebacks

Traditional Contemporary

Fyreback Dimension Chart

	A*	B	C	D
SMALL (for 18" log sets)	16"	16.5"	11"	14"
MEDIUM (for 24" log sets)	16"	21.5"	12"	14"
LARGE (for 30" log sets)	16"	26.5"	13"	14"
X LARGE (for 36" log sets)	16"	31.5"	14"	14"

* Add 1" to A dimension for Traditional Models

DESCRIPTION	SIZE	Traditional #	Contemporary #	WT.	PRICE
Satin Stainless Fyreback	S	FBS-18	FBC-18	10 lb.	\$128
	M	FBS-24	FBC-24	12	146
	L	FBS-30	FBC-30	14	162
	XL	FBS-36	FBC-36	17	179
Polished Stainless Steel Fyreback	S	FBSP-18	FBCP-18	10	196
	M	FBSP-24	FBCP-24	12	206
	L	FBSP-30	FBCP-30	14	220
	XL	FBSP-36	FBCP-36	17	273
Black Porcelain Fyreback	S	FBSB-18	FBCB-18	10	198
	M	FBSB-24	FBCB-24	12	214
	L	FBSB-30	FBCB-30	14	237
	XL	FBSB-36	FBCB-36	17	276

C. Decor Packs, Refresh Kit, & Burner Affix Kit



DESCRIPTION	INCLUDES	MODEL #	WT.	PRICE
Decor Pack (Case of 6)	4 small size Wood Chips and 3 small size Pine Cones (vacuum packed)	DP-2-6	18 lb.	\$445
Ember Enhancing Decor Pack	Bryte Coals, Lava Coals, 2 Pine Cones, and 2 Wood Chips	DP-5	10	113
Ember Enhancing Decor Pack	Bryte Coals, Lava Coals, 2 Pine Cones, 2 Wood Chips, and 2 Acorns	DP-7	12	121
Holiday Decor Pack (Case of 6)	2 Acorns, 2 Pine Cones, and 4 Wood Chips (vacuum packed)	HDK-1-6	18	630
Refresh Kit	Ember Glow, Sand (NG) or Vermiculite (LP), Bryte Coals, Lava Granules, and Acorns	RK-1 / RK-1P	26	135
Burner Affix Kit	Mounting Bracket, Screw, and Silicone	AFK-1	1	38

D. Decorative Branches & Bonus Logs



DESCRIPTION	MODEL #	WT.	PRICE
9" Oak Branches (2 in a box)	BR-2	3 lb.	\$51
17" Oak Branch	BR-17	6	62
Charred Branches (4 vacuum packed)	BDC-4	11	124
Charred Accessory Kit (4 pcs. vacuum packed)	Single CHA-1	2	80
	Case of 6 CHA-1-6	12	482
Special Designer Bonus Logs (2 in a box)	SD-BONUS	13	108
Special Split Logs (2 in a box)	SS-BONUS	8	118
Special Birch Bonus Logs (2 in a box)	SB-BONUS	12	120
Charred Series Chunk	CHC-01	2	33
Wood Chip Ring (vacuum packed)	WCRD-1	3	46

E. River Rocks & Wood Chunks



DESCRIPTION	COLOR	MODEL #	PRICE
River Rock Fyre Stones (set of 10 assorted sizes)	Assorted	STN-10	\$142
	Ivory	STN-10I	
	Slate	STN-10S	
	Terracotta	STN-10T	
Designer River Rock Fyre Stones (set of 20 assorted sizes)	Assorted	STN-20	332
Designer Wood Chunks (set of 36 assorted sizes)	--	WCD-36	310

2
0
2
5
-
2
0
2
6

Gas Logs

VIII Accessories



F. Pine Cones, Wood Chips, & Acorns

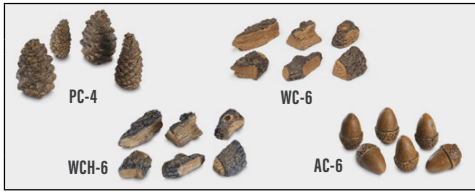

DESCRIPTION	MODEL #	WT.	PRICE
4 Designer Pine Cones <i>(assorted sizes, vacuum packed)</i>	Case of 6 PC-4-6	22 lb.	\$328
6 Wood Chips <i>(vacuum packed)</i>	Case of 6 WC-6-6	22	393
6 Charred Wood Chips <i>(vacuum packed)</i>	Case of 6 WCH-6-6	22	440
6 Acorns <i>(vacuum packed)</i>	Case of 6 AC-6-6	15	281

G. Gas Log Burner Kit Accessories



DESCRIPTION	MODEL #	WT.	PRICE
Ember Glow	Single EM-1	6 oz.	\$29
	Case of 12 EM1-12	5 lb.	338
Super Embers <i>(includes Bryte Coals)</i>	EM-1S	7 oz.	56
Bryte Coals	EM-11	2 oz.	34
Black Embers	Single EB-1	6 oz.	36
	Case of 12 EB-12	5 lb.	418
Select White Sand <i>(10 lb. bag)</i>	Single CS-10	10 lb.	29
	Case of 6 CS-10-6	66 lb.	169
Vermiculite Granules	Single LF-15	1.5 lb.	33
	Case of 12 LF-15-12	18 lb.	386
Lava-Fyre Granules <i>(5 lb. bag)</i>	Single LF-5	5 lb.	25
	Case of 12 LF-5-12	68 lb.	287
Lava-Fyre Granules <i>(10 lb. bag)</i>	Single LF-10	10 lb.	40
	Case of 6 LF-10-6	63 lb.	232
Lava-Fyre Coals <i>(10 lb. bag)</i>	Single LFC-10	10 lb.	47
	Case of 6 LFC-10-6	66 lb.	274
Assorted Lava Stones <i>(15 lb. box)</i>	LVS-15	15 lb.	68
Assorted Lava Stones <i>(35 lb. box)</i>	LVS-35	35 lb.	110

H. Additional Accessories

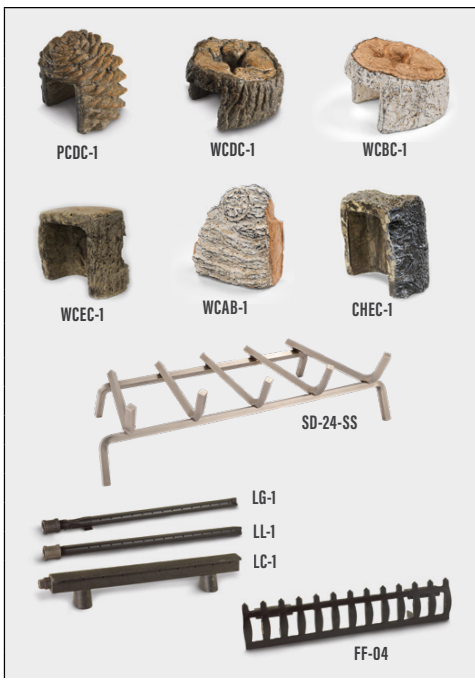

DESCRIPTION	MODEL #	WT.	PRICE
Charred Birch Decorative Cover <i>(vacuum packed)</i>	Single WCBC-1	2 lb.	\$62
	Case of 6 WCBC-1-6	12 lb.	362
Charred Birch Decorative Wood Chunk	Single WCAB-1	2 lb.	62
	Case of 6 WCAB-1-6	12 lb.	364
Wood Chunk Decorative Cover <i>(vacuum packed)</i>	Single WCDC-1	2 lb.	52
	Case of 6 WCDC-1-6	12 lb.	305
Pine Cone Decorative Cover <i>(vacuum packed)</i>	Single PCDC-1	2 lb.	56
	Case of 6 PCDC-1-6	12 lb.	329
Valve Cover, Designer <i>(vacuum packed)</i>	WCEC-1	7 lb.	68
Valve Cover, Charred <i>(vacuum packed)</i>	CHEC-1	7 lb.	67
Stainless Steel Grate <i>(recommended for Outdoor Fireplaces)</i>	18" size SD-18-SS	11 lb.	247
	24" size SD-24-SS	12 lb.	390
	30" size SD-30-SS	15 lb.	465
Rigid Gas Log Lighter <i>(for Natural Gas Only)</i>	Single LG-1	2 lb.	59
	Case of 12 LG-1-12	19 lb.	693
Gasaver Gas Log Lighter <i>(for Natural Gas Only)</i>	Single LL-1	2 lb.	69
	Case of 12 LL-1-12	19 lb.	821
14" Cast Iron Gas Log Lighter <i>(for Natural Gas Only)</i>	LC-1	5 lb.	95
	18" size FF-04-18	8 lb.	73
	24" size FF-04-24	10 lb.	84
Cast Iron Fender <i>(for All Gas Log Sets)</i>	30" size FF-04-30	12 lb.	101

Stock: Y = Stock, N or * = Non-Stock, LTSD = Limited to Stock on Hand

Non-Stock Item Notice: Items marked non-stock must be ordered in case quantities

Gas Logs

Vent-Free Systems



G8E Series Vent-Free System

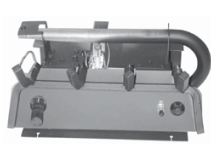

G8E Burner



Valley Oak

G8E Series Gas Log Sets are ANSI Certified and Include: Vent Free Gas Logs • Decorative Front Panel • Certified Vent Free Burner with pre-assembled Control Valve and ODS Safety System • Custom Grate • Connector Kit.
Shipped for use w/ Natural Gas - specify if for Propane Gas by adding a "P" to the model number (e.g. G8E-16/20/24P).

G8E Series (Burners Only)

Description / wt.	Control	Model #	16"/20"/24"	
G8E Burner (20,000 BTU's) Weight: 12#	Manual	G8E-**	\$511	
	On/Off Remote*	G8E-**-12	885	
	NEW Variable Remote*	G8E-**-15	969	
G8E Burner (9,500 BTU's) Weight: 12#	Manual	G8E-**-R	511	
	On/Off Remote*	G8E-**-R-12	885	

G8E Series (Gas Logs Only)

Description	Fireplace	Model #	16"	20"	24"
Valley Oak	Standard	V08E-**	\$298 25#	\$338 29#	\$376 35#
Split Valley Oak	Standard	SV08E-**	320 #	360 #	398 #

G9 Series Vent-Free System

G9 Standard Burner

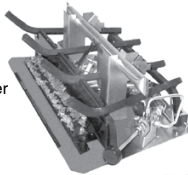

Split Oak

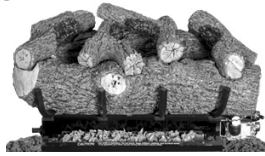

Meadow Oak

G9 Series Vent Free Gas Log Sets are ANSI Certified and Include: Vent Free Gas Logs • Certified Vent Free Burner with pre-assembled Control Valve and ODS Safety System • Custom Grate • Connector Kit • Glowing Embers • Bryte Coals • Lava-Fyre Granules.
Shipped for use w/ Natural Gas - specify if for Propane Gas by adding a "P" to the model number (e.g. G9-20/24/30P).

G9 Series (Burners Only)

Description / Wt.	Control	Model #	20"/24"/30"	
G9 Burner System Weight: 22-23#	Manual	G9-**	\$699	
	On/Off Remote*	G9-**-12	1,072	
	Variable Remote*	G9-**-15	1,187	
G9 See-thru Burner System Weight: 36#	On/Off Remote*	G9-2-**-12	1,415	

G9 Series (Gas Logs Only)

Description	Fireplace	Model #	20"	24"	30"
Golden Oak Designer	Standard	RD9-**	\$291 32#	\$316 35#	\$397 49#
	See Thru	RD9-2-**	--	420 50#	--
Split Oak	Standard	S9-**	314 31#	343 34#	429 46#
	See Thru	S9-2-**	--	468 50#	--
Meadow Oak	Standard	M9-**	302 #	327 #	408 #
	See Thru	M9-2-**	--	435 #	--

G10 Series Vent-Free System

Featuring the Vent-Free I-2000 Plus Burner System

G10 Burner

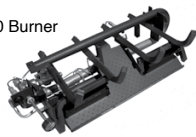

Charred Alpine Birch



Charred Aged Split Oak



Charred Frontier Oak

G10 Series Vent Free Gas Log Sets are ANSI Certified and Include: Vent Free Gas Logs • Certified Vent Free Burner with pre-assembled Control Valve and ODS Safety System • Custom Grate • Connector Kit • Glowing Embers • Bryte Coals • Lava-Fyre Granules.
Shipped for use w/ Natural Gas - specify if for Propane Gas by adding a "P" to the model number (e.g. G10-24/30P).

G10 Series (Burners Only)

Description / Wt.	Control	Model #	16"/18"	24"/30"
G10 Burner System Weight: 16"/18" - 22-25# Weight: 24"/30" - 26-30#	Manual	G10-**	\$877	\$980
	Variable Remote*	G10-**-15	1,346	1,449
	Electronic Remote*	G10-**-01V	1,710	1,813
G10 Burner System (Stainless Steel) Weight: 16"/18" - 22-25# Weight: 24"/30" - 26-30#	Manual	G10-**-SS	1,510	1,621
	Variable Remote*	G10-**-15-SS	1,983	2,094
	Electronic Remote*	G10-**-01V-SS	2,368	2,479

G10 Series (Gas Logs Only)

Description	Fireplace	Model #	16/18"	24"	30"
Charred Frontier Oak	Standard	CHFR-**	\$364 35#	\$416 41#	\$517 48#
Charred Aged Split	Standard	CHAS-**	399 35#	459 41#	564 48#
Charred Alpine Birch	Standard	CHAB-**	467 35#	526 41#	625 48#
Charred Gnarled Split	Standard	CHGS-**	482 35#	548 41#	650 48#
Gnarled Oak	Standard	GNO-**	450 35#	508 41#	602 48#

*Remote Systems include basic Transmitter and Receiver.

All Vent-Free sets packed in two cartons, to order: Select Burner System (i.e. G10-24/30) and then Gas Log Style (i.e. CHFR-24).

2
0
2
5
-
2
0
2
6

Gas Logs

Vent-Free Systems (Continued)



G18 Series Vent-Free System



Evening Fyre



G18 See-thru Burner



G18 Standard Burner

G18 Series Vent Free Gas Logs sets are ANSI certified and include: Vent Free Gas Logs • Certified Vent Free Burner with pre-assembled Control Valve and ODS Safety System • Custom Grate • Connector Kit • Glowing Embers • Bryte Coals • Lava-Fyre Granules • Wood Chunks. Shipped for use w/ Natural Gas - specify if for Propane Gas by adding a "P" to the model number (e.g. G18-24/30P).

G18 Series (Burners Only)

Description / Wt.	Control	Model #	16"/18"	24"/30"
G18 Burner System Weight: 26-30#	Manual	G18-**-*	\$995	\$1,115
	Variable Remote*	G18-**-15	1,482	1,602
	Electronic Remote*	G18-**-01V	1,808	1,928
G18 See-thru Burner System Weight: 35-40#	Variable Remote*	G18-2-**-15	1,784	1,904

G18 Series (Gas Logs Only)

Description	Fireplace	Model #	16"/18"	24"	30"
Evening Fyre Charred	Standard	ECV-**-*	\$435 33#	\$497 38#	\$593 44#
	See-Thru	ECV-2-**-*	552 45#	613 52#	--
Evening Fyre	Standard	EFV-**-*	388 35#	441 41#	534 48#
	See-Thru	EFV-2-**-*	497 50#	561 55#	--
Evening Fyre Split	Standard	ESV-**-*	426 35#	486 41#	576 48#
	See-Thru	ESV-2-**-*	538 50#	602 55#	--

G19A Series Vent-Free System



G19A Burner

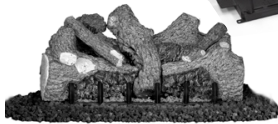

Foothill Oak



Foothill Split Oak

G19A Series Vent-Free Gas Logs sets are ANSI Certified and include: Uniquely Designed Vent-Free Gas Logs • Certified Vent Free Burner with pre-assembled Remote Control Valve & ODS Safety System • Custom Grate • Connector Kit • Glowing Embers • Lava Granules. Shipped for use w/ Natural Gas - specify if for Propane Gas by adding a "P" to the model number (e.g. G19A-24/30-15P).

G19A Series (Burners Only)

Description / Wt.	Control	Model #	18"/20"	24"/30"
G19A Burner System Weight: 18"/20" - 30# Weight: 24"/30" - 36#	Variable Remote*	G19A-**-15	\$1,494	\$1,572
	Electronic Remote*	G19A-**-01V	1,817	1,895

G19A Series (Gas Logs Only)

Description	Fireplace	Model #	18"	24"	30"
Foothill Oak	Standard	FTO-**-*	\$398 33#	\$449 50#	\$541 60#
Foothill Split Oak	Standard	FTSO-**-*	433 33#	491 50#	589 54#

G21 Series Vent-Free System

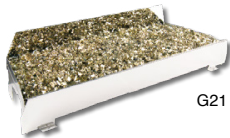

G21 Standard Burner

G21 Series Glass Burner with On/Off Remote

Description	Trim	Model #	18"	24"	30"
G21 Glass Burner Weight: 20-30#	Standard	G21-GL-**-12	\$1,486	\$1,602	\$1,670
G21 Glass Burner (See-Thru) Weight: 25-35#	Standard	G21-GL-2-**-12	1,741	1,866	--

G21 Series Vent-Free Glass sets are ANSI certified and include: Stainless Steel Certified Vent-Free Burner with pre-assembled Remote Control Valve and ODS Safety System • Polished Reflective Panel • See-Thru includes Glass Front Panels. Shipped for use w/ Natural Gas - specify if for Propane Gas by adding a "P" to the model number (e.g. G21-GL-24-12P). Amount of glass required is 7½ lbs for 18", 10 lbs for 24", and 15 lbs for 30". (18" See-Thru 10 lbs & 24" See-Thru 12½ lbs).

Fyre Glass	10 lb. Package	40 lb. Bucket
Azuria	GL-10-F	GL-40-F
Black	GL-10-B	GL-40-B
Bronze	GL-10-Z	GL-40-Z
Caribbean Blue	GL-10-N	GL-40-N
Clear	GL-10-C	GL-40-C
Emerald	GL-10-E	GL-40-E
Star Fyre	GL-10-W	GL-40-W



Refl. Fyre Glass	10 lb. Package	40 lb. Bucket
Azuria Reflective	GL-10-FR	GL-40-FR
Black Reflective	GL-10-BR	GL-40-BR
Bronze Reflective	GL-10-ZR	GL-40-ZR
Caribbean Blue Refl.	GL-10-NR	GL-40-NR
Copper Reflective	GL-10-OR	GL-40-OR
Emerald Reflective	GL-10-ER	GL-40-ER
Gold Reflective	GL-10-HR	GL-40-HR
Champagne Reflective	GL-10-CR	GL-40-CR



Fyre Gems	10 lb. Package	40 lb. Bucket
Black Pearl	GLG-10-J	GLG-40-J
Blue Topaz	GLG-10-T	GLG-40-T
Champagne	GLG-10-D	GLG-40-D
Deep Amber	GLG-10-A	GLG-40-A
Emerald	GLG-10-E	GLG-40-E
Glacier	GLG-10-C	GLG-40-C
Sapphire	GLG-10-S	GLG-40-S
Ruby	GLG-10-RY	GLG-40-RY



Stock: Y = Stock, N or * = Non-Stock, LTSD = Limited to Stock on Hand

Non-Stock Item Notice: Items marked non-stock must be ordered in case quantities

Gas Logs

Individual Vent-Free Gas Logs Only



To Order: Specify Log Style and then Size (i.e. CHFRL-20BR)

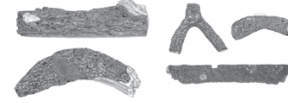

G8E Series	LOGS STYLE (Top & Bottom)	No.	8tl	8ty	10tl	11tr	12br	16bf	20bf	24bf
	Valley Oak	VOL8E	\$46	46	48	55	88	101	147	195

G9 Series	LOGS STYLE (Top & Bottom)	No.	8tr-2	8t-2	10ty-2	9ty	10tc	10tr	10ty	11t	11tl	17br	20bf	20br	24bf	24bf-2	30bf
	Golden Oak Designer	RDL9	\$44	45	45	47	47	47	51	--	51	88	133	133	146	146	190
	Split Oak	SL9	\$46	48	48	51	51	51	57	51	57	97	140	140	149	149	197

G10 Series	LOGS STYLE (Top & Bottom)	No.	6tc	7t	8t	9t	9tr	10t	10tl	10tr	11t	11tl	11tr	12tr	12tl	13t	14tr	15tl	15br	16/18bf	19br	20br	21br	24bf	24br	30bf
	Charred Frontier Oak	CHFRL	\$44	46	--	--	48	51	--	--	--	53	--	64	64	--	77	77	102	133	--	147	--	158	158	196
	Charred Aged Split	CHASL	\$47	49	--	53	53	57	--	57	--	58	--	68	68	--	82	82	108	140	--	156	--	163	163	199
	Charred Alpine Birch	CHABL	--	--	\$60	62	--	--	75	75	65	71	71	--	--	77	--	--	156	163	168	--	181	184	--	205

G18 Series Top Logs	LOGS STYLE (Top)	No.	8t	9t	10t	11tr	12t	12tl	12ty	13t	13ty	17ty	-2-11ty	-2-9t	-2-10t	-2-12t
	Evening Fyre Charred	ECVL	--	\$63	64	68	77	77	--	79	79	113	79	65	68	82
	Evening Fyre	EFVL	--	\$62	62	62	67	67	--	74	74	104	68	60	62	71
	Evening Fyre Split	ESVL	\$60	62	63	67	74	--	77	--	--	108	77	63	65	78

G18 Series Bottom Logs	LOGS STYLE (Bottom)	No.	15br	18bf	20br	24bf	24br	30bf	-2-18B1	-2-18B2	-2-24BF
	Evening Fyre Charred	ECVL	\$118	148	159	173	173	234	148	148	173
	Evening Fyre	EFVL	\$108	140	148	160	160	222	140	140	160
	Evening Fyre Split	ESVL	\$115	146	156	167	167	227	146	146	167

G19A Series Top Logs	LOGS STYLE (Top)	No.	7t	8t	9t	10t	10tl	10tr	11t	12t	12tc	13t	13tr	14t	15t
	Foothill Oak	FTOL	--	\$60	62	63	63	--	64	65	--	74	--	--	92
	Foothill Split Oak	FTSOL	\$53	60	62	63	--	63	--	67	77	74	74	87	--

G19A Series Bottom Logs	LOGS STYLE (Bottom)	No.	17br	18bf	22br	23br	24bf	30bf
	Foothill Oak	FTOL	\$113	167	151	160	174	245
	Foothill Split Oak	FTSOL	\$113	167	151	--	174	245

Vent-Free Accessories & Replacement Parts

A. Vent Free Valve & Control Body Options

MODEL	DESCRIPTION	PRICE
SV-18	Valve for G8E Manual - (Natural or Propane)	\$145
SV-26	Valve for G9, G10 & G18 Manual - (Natural)	118
SV-27	Valve for G9, G10 & G18 Manual - (Propane)	118
SV-24	Control Body for G10-15 & G18-15 - (Natural)	377
SV-25	Control Body for G10-15P & G18-15P - (Propane)	377
SV-8	Control Body for Remote Style (-12) G8E & G9 - (N.G.)	305
SV-8P	Control Body for Remote Style (-12P) G8E & G9 - (L.P.)	305
SV-43	Control Body for Remote Style (-12) G21 - (Natural)	305
SV-43P	Control Body for Remote Style (-12P) G21 - (Propane)	305
SV-42	Control Body for Variable Remote Style (01V) G10 & G18	435
SV-41	Control Body for Variable Remote Style (01VP) G10 & G18	435
SV-51	Control Body for G19A-15 - (Natural)	377
SV-51P	Control Body for G19A-15P - (Propane)	377
SV-46	Control Body for G19A-01V - (Natural)	464
SV-46P	Control Body for G19A-01VP - (Propane)	464

B. Remote Compatible Options

MODEL	DESCRIPTION	PRICE
RR-1A	Basic ON/OFF Receiver/Transmitter Set	\$123
RR-2A	Deluxe ON/OFF Receiver/Transmitter Set	179
VR-1A	Basic Variable Receiver/Transmitter Set for "15" models	149
VR-2A	Deluxe Variable Receiver/Transmitter Set for "15" models	204
WCDC-1	Wood Chunk Decorative Cover (Vacuum packed)	52
PCDC-1	Pine Cone Decorative Cover (Vacuum packed)	56
WCBC-1	Charred Birch Decorative Cover (Vacuum packed)	62
WCAB-1	Charred Birch Decorative Wood Chunk	62
RF-BTSR1-G	ON/OFF Bluetooth Control w/ Golden Oak Cover ("12" Product Only)	234
RF-BTSR1-B	ON/OFF Bluetooth Control w/ White Birch Cover ("12" Product Only)	240
TS-12	Thermostat Control ("12" Product Only)	85
WS-1	Wall Switch, Cover and Wiring ("12" Product Only)	71
WS-2	Wall Timer, Cover and Wiring ("12" Product Only)	174
WS-3	Wall Switch, Cover and Wiring ("15" Product Only)	87
WS-6	Wall Switch ("01V" Product Only)	148
TR-03	Power Supply ("01V" Product Only)	134

C. Accessories

MODEL	DESCRIPTION	PRICE
DP-2-6	Valley Oak Wood Chips (4) and Pine Cones (3) (vacuum packed, case of 6)	\$445
PC-4-6	4 Designer Pine Cones (assorted sizes, vacuum packed, case of 6)	328
WC-6-6	6 Wood Chips (vacuum packed, case of 6)	393
WCH-6-6	6 Charred Wood Chips (vacuum packed, case of 6)	440
AC-6-6	6 Acorns (vacuum packed, case of 6)	281
LFC-6	Lava Fyre Coals - Wt. 6#	32
LF-5	Lava Fyre Granules - Wt. 5#	25
VFRK-1	Refresh Kit (incl.: 5# lava granules, Ember Glow, Bryte Coals & 6 Acorns)	86

D. Three-Panel Fyrebacks

DESCRIPTION	SIZE	FYREBACK MODEL #		PRICE
		Traditional	Contemporary	
Three-Panel Fyrebacks Satin Stainless	S	FBS-18	FBC-18	\$128
	M	FBS-24	FBC-24	146
	L	FBS-30	FBC-30	162
Three-Panel Fyrebacks Polished Stainless Steel	XL	FBS-36	FBC-36	179
	S	FBSP-18	FBCP-18	196
	M	FBSP-24	FBCP-24	206
Three-Panel Fyrebacks Black Porcelain	L	FBSP-30	FBCP-30	220
	XL	FBSP-36	FBCP-36	273
	S	FBSB-18	FBCB-18	198
Three-Panel Fyrebacks	M	FBSB-24	FBCB-24	214
	L	FBSB-30	FBCB-30	237
	XL	FBSB-36	FBCB-36	276

E. Oxygen Depletion Sensor / Repl. Embers

MODEL	DESCRIPTION	PRICE
ODS-0001	Natural Gas	\$69
ODS-0002	Propane Gas	69
ODS-0003	Natural Gas with "12" Valve	134
ODS-0004	Propane Gas with "12" Valve	134
EM-9	Replacement Embers (G9)	20
EM-10	Replacement Embers (G10, G18, & G19A)	23

2
0
2
5
-
2
0
2
6

Gas Logs

Hargrove Gas Logs (Vented)
Single Sided Loose Logs - Fresh Cut and Charred



2
0
2
5
-
2
0
2
6

Single Side Vented Loose Logs - Fresh Cut Series

When ordering a full log set, choose a log set below and match it w/accessory kit

Item Code	Item Name	Ship Weight	Retail Price	Stocked
Fresh Cut Series - Classic Oak				
HGCLS1504AA	Classic Oak 4 Piece Loose Log Set, 15"	16 lbs.	\$ 120.00	N
HGCLS1805AA	Classic Oak 5 Piece Loose Log Set, 18"	32 lbs.	\$ 213.00	N
HGCLS2105AA	Classic Oak 5 Piece Loose Log Set, 21"	41 lbs.	\$ 244.00	Y
HGCLS2406AA	Classic Oak 6 Piece Loose Log Set, 24"	44 lbs.	\$ 268.00	Y
HGCLS3007AA	Classic Oak 7 Piece Loose Log Set, 30"	58 lbs.	\$ 369.00	Y
Fresh Cut Series - Grand Oak				
HGGOS1805AA	Grand Oak 5 Piece Loose Log Set, 18"	68 lbs.	\$ 291.00	Y
HGGOS2105AA	Grand Oak 5 Piece Loose Log Set, 21"	46 lbs.	\$ 342.00	Y
HGGOS2406AA	Grand Oak 6 Piece Loose Log Set, 24"	68 lbs.	\$ 447.00	Y
HGGOS3007AA	Grand Oak 7 Piece Loose Log Set, 30"	93 lbs.	\$ 577.00	Y
Fresh Cut Series - Hargrove Select				
HGHSS1807AA	Hargrove Select 7 Piece Loose Log Set, 18"	41 lbs.	\$ 332.00	Y
HGHSS2409AA	Hargrove Select 9 Piece Loose Log Set, 24"	69 lbs.	\$ 577.00	Y
HGHSS3010AA	Hargrove Select 10 Piece Loose Log Set, 30"	94 lbs.	\$ 712.00	Y
HGHSS4813AA	Hargrove Select 13 Piece Loose Log Set, 48"	165 lbs.	\$ 1,234.00	Y
Fresh Cut Series - Mountain Timber				
HGMTS2406AA	Mountain Timber 6 Piece Loose Log Set, 24"	74 lbs.	\$ 848.00	Y
Fresh Cut Series - Western Pine				
HGWPS2106AA	Western Pine Loose Log Set, 21"	38 lbs.	\$ 388.00	N



Classic Oak



Hargrove Select



Mountain Timber



Western Pine

Single Side Vented Loose Logs - Charred Series

When ordering a full log set, choose a log set below and match it w/accessory kit

Item Code	Item Name	Ship Weight	Retail Price	Stocked
Charred Series - Blazing Pecan				
HGBPS2104AA	Blazing Pecan Loose Log Set, 21"	44 lbs.	\$ 479.00	N
Charred Series - Inferno				
HGISS1805AA	Inferno Series Loose Log Set, 18"	23 lbs.	\$ 294.00	Y
HGISS2106AA	Inferno Series 6 Piece Loose Log Set, 21"	29 lbs.	\$ 353.00	Y
Charred Series - Magnificent Inferno				
HGMIS2106AA	Magnificent Inferno 6 Piece Loose Log Set, 21"	41 lbs.	\$ 450.00	Y
HGMIS2407AA	Magnificent Inferno 7 Piece Loose Log Set, 24"	50 lbs.	\$ 555.00	Y
HGMIS3008AA	Magnificent Inferno 8 Piece Loose Log Set, 30"	62 lbs.	\$ 694.00	Y
Charred Series - Supreme Ponderosa				
HGSPS3008AA	Supreme Ponderosa Loose Log Set, 30"	111 lbs.	\$ 934.00	Y
HGSPS4812AA	Supreme Ponderosa 12 Piece Loose Log Set, 48"	176 lbs.	\$ 1,596.00	Y
Charred Series - Twilight Inferno				
HGTIS2106AA	Twilight Inferno 6 Piece Loose Log Set, 21"	37 lbs.	\$ 489.00	Y
HGTIS2407AA	Twilight Inferno 7 Piece Loose Log Set, 24"	51 lbs.	\$ 595.00	Y
HGTIS3008AA	Twilight Inferno 8 Piece Loose Log Set, 30"	59 lbs.	\$ 732.00	N
HGTIS3610AA	Twilight Inferno 10 Piece Loose Log Set, 36"	76 lbs.	\$ 864.00	Y

Gas Logs

Hargrove Gas Logs (Vented)

Single Sided Loose Logs Radiant and E-Burner Kits



Single Side Vented Loose Logs - Radiant Series

Item Code	Item Name	Ship Weight	Retail Price	Stocked
Radiant Series - Aspen Timbers				
HGATS2113RG	Aspen Timbers 13 Piece Loose Log Set, 21"	12 lbs.	\$ 858.00	Y
HGATS2414RG	Aspen Timbers 14 Piece Loose Log Set, 24"	15 lbs.	\$ 967.00	Y
HGATS3015RG	Aspen Timbers 15 Piece Loose Log Set, 30"	21 lbs.	\$ 1,077.00	Y
HGATS3616RG	Aspen Timbers 16 Piece Loose Log Set, 36"	22 lbs.	\$ 1,136.00	Y
Radiant Series - Canyon Timbers				
HGCYS2113RG	Canyon Timbers Loose Log Set, 21"	12 lbs.	\$ 709.00	Y
HGCYS2416RG	Canyon Timbers Loose Log Set, 24"	15 lbs.	\$ 820.00	Y
HGCYS3017RG	Canyon Timbers Loose Log Set, 30"	20 lbs.	\$ 933.00	Y
HGCYS3619RG	Canyon Timbers Loose Log Set, 36"	61 lbs.	\$ 974.00	Y
Radiant Series - Cross Timbers				
HGCTS2108RG	Cross Timbers 8 Piece Loose Log Set, 21"	12 lbs.	\$ 622.00	Y
HGCTS2409RG	Cross Timbers 9 Piece Loose Log Set, 24"	15 lbs.	\$ 728.00	Y
HGCTS3010RG	Cross Timbers 10 Piece Loose Log Set, 30"	20 lbs.	\$ 841.00	Y
HGCTS3611RG	Cross Timbers 11 Piece Loose Log Set, 36"	21 lbs.	\$ 914.00	Y
Radiant Series - Rustic Timbers				
HGRTS2110RG	Rustic Timbers 10 Piece Loose Log Set, 21"	11 lbs.	\$ 674.00	Y
HGRTS2411RG	Rustic Timbers Loose Log Set, 24"	14 lbs.	\$ 764.00	Y
HGRTS3012RG	Rustic Timbers 12 Piece Loose Log Set, 30"	16 lbs.	\$ 875.00	Y
HGRTS3614RG	Rustic Timbers 14 Piece Loose Log Set, 36"	18 lbs.	\$ 930.00	Y
Radiant Series - Woodland Timbers				
HGWTS2116RG	Woodland Timbers 16 Piece Loose Log Set, 21"	12 lbs.	\$ 720.00	Y
HGWTS2418RG	Woodland Timbers 18 Piece Loose Log Set, 24"	15 lbs.	\$ 834.00	Y
HGWTS3020RG	Woodland Timbers 20 Piece Loose Log Set, 30"	20 lbs.	\$ 944.00	Y
HGWTS3622RG	Woodland Timbers 22 Piece Loose Log Set, 36"	21 lbs.	\$ 991.00	Y



Aspen Timbers



Cross Timbers



Rustic Timbers



E Burner

E-Burner Vented Kits

Minimum 14" depth required, includes burner, grate, sand or vermiculite, embers, volcanic cinder, fittings and a black flex connector

Item Code	Item Name	Ship Weight	Retail Price	Stocked
No Safety Pilot - Match Light				
HG18RNEB0A5	18" - 21" E-Burner Vented Kit, NG	32 lbs.	\$ 305.00	Y
HG24RNEB0A5	24" E-Burner Vented Kit, NG	39 lbs.	\$ 337.00	Y
HG30RNEB0A5	28" - 30" E-Burner Vented Kit, NG	40 lbs.	\$ 387.00	Y
HG36RNEB0A5	36" E-Burner Vented Kit, NG	53 lbs.	\$ 495.00	Y
Factory Installed Latchtap w/On/Off Remote				
HG18RNEB1H5	18" - 21" E-Burner Vented Kit, NG	32 lbs.	\$ 946.00	Y
HG24RNEB1H5	24" E-Burner Vented Kit, NG	39 lbs.	\$ 978.00	Y

Stock: Y = Stock, N or * = Non-Stock, LTSD = Limited to Stock on Hand

Non-Stock Item Notice: Items marked non-stock must be ordered in case quantities

Hargrove Gas Logs (Vented)

H-Burner and System 4 Kits



2
0
2
5
-
2
0
2
6

H-Burner Vented Kits				
Minimum 14" depth required, includes burner, grate, sand or vermiculite, embers, volcanic cinder, fittings and a black flex connector				
Item Code	Item Name	Ship Weight	Retail Price	Stocked
No Safety Pilot - Match Light				
HG18RNHB0A5	18" - 21" H-Burner Vented Kit, NG	29 lbs.	\$ 370.00	Y
HG24RNHB0A5	24" H-Burner Vented Kit, NG	32 lbs.	\$ 400.00	Y
HG30RNHB0A5	28-30" H-Burner Vented Kit, NG	39 lbs.	\$ 451.00	Y
HG36RNHB0A5	36" H-Burner Vented Kit, NG	53 lbs.	\$ 561.00	Y
Factory Installed Safety Pilot				
HG24RNHB1B5	24" H-Burner Vented Kit, NG	32 lbs.	\$ 647.00	Y
Factory Installed Latchtap Pilot w/Remote Control				
HG18RNHB1H5	18" - 21" H-Burner Vented Kit, NG	29 lbs.	\$ 1,011.00	Y
HG24RNHB1H5	24" H-Burner Vented Kit, NG	32 lbs.	\$ 1,041.00	Y
HG24RPHB1K5	24" H-Burner Accessory Kit, Variable Flame, LP	39 lbs.	\$ 1,051.07	Y
Factory Installed Pilot w/Variable Remote				
HG18RNHB1F5	18" - 21" H-Burner Vented Kit, NG	33 lbs.	\$ 1,109.00	N
Factory Installed Variable Flame w/Remote Control				
HG24RNHB1F5	24" H-Burner Vented Kit, NG	32 lbs.	\$ 1,139.00	Y
Factory Installed Millivolt Pilot w/Wall Switch				
HG24RNHB2A5	24" H-Burner Vented Kit, NG	32 lbs.	\$ 1,010.00	N



H Burner

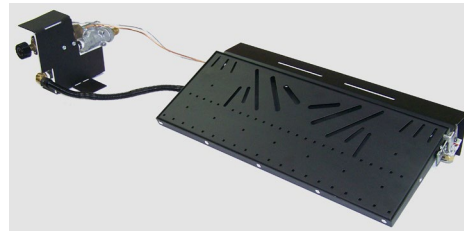

System 4 Burner

Standard System 4 Burner Kits				
Specialized for LP gas				
Item Code	Item Name	Ship Weight	Retail Price	Stocked
Factory Installed Safety Pilot				
HG18CPSF1B5CMT	18" - 21" System 4 Burner Kit, LP	29 lbs.	\$ 797.00	Y
HG24CPSF1B5CMT	24" System 4 Burner Kit, LP	32 lbs.	\$ 834.00	Y
HG30CPSF1B5CMT	28" - 30" System 4 Burner Kit, LP	36 lbs.	\$ 871.00	Y
Factory Installed Pilot w/Variable Remote				
HG30CPSF1F5CMT	30" LP Cool Mount Accessory Kit	36 lbs.	\$ 1,363.00	Y
Factory Installed Latchtap w/On/Off Remote				
HG18CPSF1H5CMT	18" - 21" System 4 Burner Kit, LP	29 lbs.	\$ 1,191.00	Y
HG24CPSF1H5CMT	24" System 4 Burner Kit, LP	32 lbs.	\$ 1,228.00	Y
HG30CPSF1H5CMT	28-30" System 4 Burner Kit, LP	36 lbs.	\$ 1,265.00	Y

Gas Logs

Hargrove Gas Logs (Vented)

Single Sided and Large Burner Kits, Large Log Sets



Single Side Vented Burner - Hidden Control Kits

Includes HC burner, grate, sand or vermiculite, embers, volcanic cinder, fittings, black flex connector

Item Code	Item Name	Ship Weight	Retail Price	Stocked
Factory Installed Safety Pilot				
HG18CNHC1T5	18-21" Single Side Vented Burner, NG	29 lbs.	\$ 738.00	N
HG24CNHC1T5	24" Single Side Vented Burner, NG	32 lbs.	\$ 770.00	N
HG30CNHC1T5	28-30" Single Side Vented Burner, NG	39 lbs.	\$ 821.00	N
HG36CNHC1T5	36" Single Side Vented Burner, NG	53 lbs.	\$ 942.00	N

Single Side Large Burner Kits

Burner pan, custom grate, sand, embers, volcanic cinder, fittings, flex connector, NG only

Item Code	Item Name	Ship Weight	Retail Price	Stocked
Mountain Timber - No Safety Pilot - Match Light				
HG36SNES0A3	36" NG Mountain Timber Large Burner Kit	79 lbs.	\$ 1,168.00	Y
Summit Oak - No Safety Pilot - Match Light				
HG42SNBB0A3	42" NG Summit Oak Large Burner Kit	75 lbs.	\$ 1,112.00	Y
Summit Oak - Factory Installed Hi-Capacity Millivolt w/Wall Switch				
HG42SPBB2B3	42" LP Summit Oak Large Burner Accessory Kit	78 lbs.	\$ 1,994.00	N

Single Side Large Vented Log Sets - Mountain Timber

When ordering a full set, choose a log kit and match it w/large burner kit

Item Code	Item Name	Ship Weight	Retail Price	Stocked
Large Log Sets - Mountain Timber				
HGMTS3608AA	Mountain Timber Large Log Set, 36"	124 lbs.	\$ 1,510.00	N



Mountain Timber



Kodiak Char
(Double Stack)



Double Stack Burner

Kodiak Double Stack Logs

Choose a double stack logset and match w/double stack accessory kit

Item Code	Item Name	Ship Weight	Retail Price	Stocked
Kodiak Char Logs - Double Stack				
HGKCS2409DS	Kodiak Char Double Stack Loose Log Set, 24"	92 lbs.	\$ 825.00	Y
HGKCS3611DS	Kodiak Char Double Stack 11 Piece Loose Log Set, 36"	162 lbs.	\$ 1,374.00	Y
Double Stack Kit No Safety Pilot - Match Light				
HG36SNDS0A8	36" NG Double Stack Burner Accessory Kit	67 lbs.	\$ 903.00	Y

Stock: Y = Stock, N or * = Non-Stock, LTSD = Limited to Stock on Hand

Non-Stock Item Notice: Items marked non-stock must be ordered in case quantities

Gas Logs

Hargrove Gas Logs (Vented)
See Thru Log Sets and Burner Kits



2
0
2
5
-
2
0
2
6

See Thru Vented Log Sets				
Field convertible to LP requires 2 pilot controls and 2 CPE-PCK or RS-PCK (one for each burner pan), sets need 22" depth, match w/accessory kit				
Item Code	Item Name	Ship Weight	Retail Price	Stocked
Classic Oak				
HGCLS2106ST	Classic Oak See Thru 6 Piece Log Set, 21"	58 lbs.	\$ 338.00	N
Cross Timbers				
HGCTS2416ST	Cross Timbers See Thru Log Set, 24"	24 lbs.	\$ 1,141.00	N
Rustic Timbers				
HGRTS2418ST	Rustic Timbers See Thru Log Set, 24"	20 lbs.	\$ 1,118.00	N
Woodland Timbers				
HGWT3029ST	Woodland Timbers See Thru Log Set, 30"	23 lbs.	\$ 1,327.00	N

See Thru Vented Burner Kits				
Includes burner, grate, sand or vermiculite, embers, volcanic cinder, fittings and connector				
Item Code	Item Name	Ship Weight	Retail Price	Stocked
No Safety Pilot - Match Light				
HG24RNST0A5	24" See Thru Vented Burner Kit, NG	54 lbs.	\$ 540.00	Y

See Thru Vented Logs - Shallow				
Field convertible to LP requires 2 pilot controls and 2 CPE-PCK or RS-PCK (one for each burner pan), sets need 22" depth, match w/accessory kit				
Item Code	Item Name	Ship Weight	Retail Price	Stocked
Classic Oak				
HGCLS2406SS	Classic Oak See Thru Shallow 6 Piece Log Set, 24"	56 lbs.	\$ 314.00	Y
Grand Oak				
HGGOS2105SS	Grand Oak See Thru Shallow Log Set, 21"	54 lbs.	\$ 404.00	N
Inferno Series				
HGISS2109SS	Inferno Series See Thru Shallow 9 Piece Log Set, 21"	39 lbs.	\$ 520.00	Y
HGISS2409SS	Inferno Series See Thru Shallow 9 Piece Log Set, 24"	53 lbs.	\$ 728.00	Y
Woodland Timbers Series				
HGWT52118SS	Woodland Timbers See Thru Shallow Log Set, 21"	11 lbs.	\$ 831.00	N

See Thru Vented Burner Kits - Shallow				
Includes stainless steel burner, grate, sand or vermiculite, embers, volcanic cinder, fittings and connector				
Item Code	Item Name	Ship Weight	Retail Price	Stocked
Factory Installed Latchtap w/On/Off Remote				
HG18RNSS1H5	18" See Thru Shallow Vented Burner Kit, NG	43 lbs.	\$ 1,045.00	N

See Thru Vented Burner Kits - System 4 - Shallow				
Includes stainless steel burner, grate, sand or vermiculite, embers, volcanic cinder, fittings and connector				
Item Code	Item Name	Ship Weight	Retail Price	Stocked
No Safety Pilot - Match Light				
HG18SNS0A1	18" System 4 See Thru Shallow Accessory Kit, NG	43 lbs.	\$ 428.34	Y
Factory Installed Safety Pilot				
HG18SPSS1B1SFCM	(HG18SPSS1B1SFCMT) 18" System 4 See Thru Shallow Accessory Kit, LP	40 lbs.	\$ 1,165.00	N
HG30SPSS1B1SFCM	(HG30SPSS1B1SFCMT) 30" System 4 See Thru Shallow Accessory Kit, LP	50 lbs.	\$ 1,276.00	Y

Gas Logs

Hargrove Gas Logs (Vented)

Full Pan Burner Kits, Specialty Shapes and Media Options



Full Pan Vented Burner Kits

Item Code	Item Name	Ship Weight	Retail Price	Stocked
No Safety Pilot Light - Match Light				
HG18SNFP0A0	18" - 21" Full Pan Vented Burner Kit, NG	35 lbs.	\$ 298.00	N
HG30SNFP0A0	28" - 30" Full Pan Vented Burner Kit, NG	52 lbs.	\$ 380.00	N
Factory Installed Variable Flame w/Remote Control				
HG24SNFP1F0	Full Pan Vented Burner Kit, NG	45 lbs.	\$ 1,082.00	N



Full Pan Burner



Specialty Shapes (Balls)

Full Pan Specialty Shapes

For use in standard, see thru, three sided or corner fireplaces

Item Code	Item Name	Ship Weight	Retail Price	Stocked
Colonial Cannon Balls - Sets				
HGFCBS2432FPBG	4" Diameter Ball Set - Beige	18 lbs.	\$ 460.00	N
HGFCBS3038FPBL	4" Diameter Ball Set - Black	20 lbs.	\$ 550.00	N
Colonial Cannon Balls - Individual Shapes				
HG7004BG	4" Diameter Ball - Beige	2 lbs.	\$ 21.00	N
HG7004BL	4" Diameter Ball - Black	2 lbs.	\$ 19.00	Y
HG7004BR	4" Diameter Ball - Brown	2 lbs.	\$ 21.00	N

Burner Media Options

Item Code	Item Name	Ship Weight	Retail Price	Stocked
Fireglass				
HGBKN10FG	(HGQMBR1010) Non-Reflective Midnight Black 1/4" Fireglass (10 lb. bag)	10 lbs.	\$ 88.50	N
HGBLN10FG	(HGQPR10) Non-Reflective Blue Lagoon 1/4" Fireglass (10 lb. bag)	10 lbs.	\$ 88.50	N
Volcanic Firepit Cinder				
HGVCFPL	1" to 3" Volcanic Cinder - 5 Gal. Bucket - 1 Cubic Ft.	30 lbs.	\$ 92.00	Y
Glass "H" Tube Burners				
HG18SNHT0A0	18" H-Tube Accessory kit - Matchlight	22 lbs.	\$ 292.00	Y
<i>"H" tube burners include sand, cinder, black non-whistling flex connectors and fittings, NG only.</i>				

Stock: Y = Stock, N or * = Non-Stock, LTSD = Limited to Stock on Hand

Non-Stock Item Notice: Items marked non-stock must be ordered in case quantities

Gas Logs

Hargrove Gas Logs (Vented/Vent-Free)
Outdoor Burners and Logs



2
0
2
5
-
2
0
2
6

Outdoor Log Burner Kit				
Includes burner, pan, grate, large and small cinder, fittings and flex connector				
Item Code	Item Name	Ship Weight	Retail Price	Stocked
Stainless Steel - Matchlight - NG				
HG30SNSK0A5	30" Outdoor Log Burner Kit, NG	60 lbs.	\$ 1,039.00	N



Wilderness Split
Outdoor

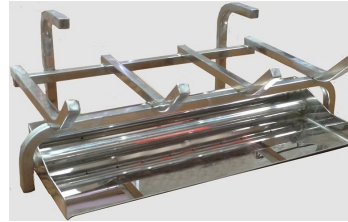

Stainless Outdoor
Log Burner Kit

Outdoor Firepit Logs				
Item Code	Item Name	Ship Weight	Retail Price	Stocked
Wilderness Split Log Sets				
HGWSS2004FL	Wilderness Split 4 Piece Firepit Log Set, 20"	30 lbs.	\$ 370.00	Y
HGWSS3007FL	Wilderness Split 7 Piece Firepit Log Set, 30"	84 lbs.	\$ 955.00	Y
Wilderness Char Log Sets				
HGWCS3010FL	Wilderness Split 10 Piece Firepit Log Set, 30"	67 lbs.	\$ 870.00	Y
HGWCS5019FL	Wilderness Split 15 Piece Firepit Log Set, 50"	140 lbs.	\$ 1,678.00	N

Gas Logs

Hargrove Gas Logs (Vented)

Olde World Basket, Pinnacle Logs (Rumford) and Burner Kits



Olde World Basket

May be ordered w/refractory logs or ceramic fiber coals, min 10" depth. Includes volcanic cinder, vermiculite, fittings, black flex connector

Item Code	Item Name	Ship Weight	Retail Price	Stocked
HGOBLO19N1T	Olde World Basket - Full Set w/Logs - NG	64 lbs.	\$ 1,150.00	N
HGOBCO19N1T	Olde World Basket - Full Set w/Coals - NG	54 lbs.	\$ 1,150.00	N
HGOBLO19P1T	Olde World Basket - Full Set w/Logs - LP	64 lbs.	\$ 1,150.00	N
Safety Pilot Remote Kits				
HGAFSCK	Variable Flame Height w/RC-S6V-ST Remote Control Included	1 lbs.	\$ 372.00	Y
Kiva Gas Log Set				
HGKIS1005AA	Kiva Logs Only	17 lbs.	\$ 227.00	Y



Olde World Basket



Pinnacle Short Stack (Seirra)



Pinnacle Mid Stack (Everest)

Pinnacle Logs

Item Code	Item Name	Ship Weight	Retail Price	Stocked
Pinacle Logs - Short Stack				
HGSR1204PL	12" Pinnacle Logs, Short Stack	6 lbs.	\$ 239.00	N
Pinacle Logs - Mid Stack				
HGEVS3008PL	30" Pinnacle Logs, Mid Stack	10 lbs.	\$ 565.00	N

Pinnacle Burner Kits

Item Code	Item Name	Ship Weight	Retail Price	Stocked
Factory Installed Safety Pilot				
HG12CNRM1T5	12" Pinnacle Burner Kits	20 lbs.	\$ 678.00	N
Electronic Ignition				
HG30CNRM3F5	30" Pinnacle Burner Kits	35 lbs.	\$ 1,542.00	N

Stock: Y = Stock, N or * = Non-Stock, LTSD = Limited to Stock on Hand

Non-Stock Item Notice: Items marked non-stock must be ordered in case quantities

Gas Logs

Hargrove Gas Logs (Vented)
Pilot Controls, Kits and Parts



2
0
2
5
-
2
0
2
6

Standard Safety Pilot Controls

Item Code	Item Name	Ship Weight	Retail Price	Stocked
Valve Heat Shields				
HGHCPCCL	Concrete, Universal Heat Shield for Standard, Latchtap, and Variable Flame Valves	1 lbs.	\$ 29.00	Y
HGHSSWU445	Metal, Universal Heat Shield for Standard, Latchtap and Variable Flame Valve	1 lbs.	\$ 29.00	Y
Valve Heat Shields				
HGCPEPO	Manual Safety Pilot Control - Parts Only	4 lbs.	\$ 214.00	Y
Latchtap Kits				
HGLCKRC	Latchtap Block Kit (ON/OFF) for CPE-PO w/RC-S6V-LT Remote Control Included	1 lbs.	\$ 397.00	Y
HGLCKBC	Latch-Tap Block Kit (ON/OFF) for CPE-PO with BPBCS Bark Chip Switch Included	1 lbs.	\$ 421.00	N
HGLCKWS	Latchtap Block Kit (ON/OFF) for CPE-PO w/WGWS Wall Switch Included	1 lbs.	\$ 356.00	N
HGLCKWWS	Latch-Tap Block Kit (ON/OFF) for CPE-PO with WS-S6V-LT Wall Switch Included	1 lbs.	\$ 439.00	N
Safety Pilot Kit Parts				
HGCPCCC	Manual Safety Pilot Control - Valve only	1 lbs.	\$ 122.00	Y
HGSPCEH	Safety Pilot Control - Extension Handle	1 lbs.	\$ 14.00	Y
HGSPCK	Safety Pilot Control - Knob Only	1 lbs.	\$ 11.00	N
HGCLCBLOCK	Latchtap Block	1 lbs.	\$ 219.00	Y
Variable Flame Safety Pilot Kits				
HGMHEPORC	Variable Flame Height Valve Kit, includes RC-S6V-MX remote, valve and pilot	5 lbs	\$ 706.00	Y
HGMHEPOBC	Variable Flame Height Valve Kit, includes BPBCS Bark Chip Switch, valve and pilot	5 lbs	\$ 667.00	N
HGMHEPOWS	Variable Flame Height Valve Kit, includes WS-S6V-WIRED Wall Switch, valve and pilot	5 lbs	\$ 599.00	N
HGMHCC	Variable Safety Pilot Control - Valve only	1 lbs.	\$ 448.00	N
HGSVO	Gearbox/Motor Remote	1 lbs.	\$ 135.00	N

Standard Cool Mount Safety Pilot Kits

Item Code	Item Name	Ship Weight	Retail Price	Stocked
Cool Mount Safety Pilot Kits				
HGCPMTPO	Cool Mount Safety Pilot Control	5 lbs.	\$ 214.00	N
HGLTCMTPORC	Cool Mount Safety Pilot with Latchtap (on/off) and Remote Control	6 lbs.	\$ 608.00	Y
HGMHCMTPORC	Cool Mount Safety Pilot with Variable Flame Height and Skytech Remote Control	6 lbs.	\$ 706.00	Y
HGMHCMTPORCA	Cool Mount Safety Pilot with Variable Flame Height and Acumen Remote Control	6 lbs.	\$ 706.00	N
HGRMCMTPO18	Cool Mount Safety Pilot w/ Millivolt Valve and Wall Switch	6 lbs.	\$ 577.00	N
HGRMBCMTPO18	High Capacity Cool Mount Safety Pilot w/ Millivolt Valve and Wall Switch	7 lbs.	\$ 816.00	N

Pilots Assembly Parts

Item Code	Item Name	Ship Weight	Retail Price	Stocked
HGRST18	18" Thermocouple - Use w/CPE or SKS	1 lbs.	\$ 21.00	Y
HGRSTPB18	18" Thermocouple & Pilot Burner Assembly - Use w/CPE or SKS (SPECIFY NG OR LP)	1 lbs.	\$ 34.00	Y
HGRSTPB36	36" Thermocouple & Pilot Burner Assembly - Use w/CPE or SKS (SPECIFY NG OR LP)	1 lbs.	\$ 46.00	Y

Hargrove Gas Logs (Vented)

Gas Valves, Accessories, Conversion Kits, Electronic Ignition



750 Millivolt Combination Gas Valves

Item Code	Item Name	Ship Weight	Retail Price	Stocked
Millivolt Safety Pilot Control				
HGRMEPO	Millivolt Safety Pilot Control - Parts Only (w/48" pilot leads)	5 lbs.	\$ 577.00	Y
High Capacity Millivolt Safety Pilot Kit				
HGRMBEPO	High Capacity (150,000 BTU) Millivolt Pilot Control - Parts Only (w/48" pilot leads)	5 lbs.	\$ 816.00	Y
Millivolt Valves and Pilot Assembly Parts				
HGRSMVNGC	Millivolt Safety Pilot Control - Valve Only	2 lbs.	\$ 409.00	N
HGRSBMVC	High Capacity (150,000 BTU) Millivolt Pilot Control - Valve Only	2 lbs.	\$ 648.00	Y
HGRSTP48	48" Thermopile for MV System	1 lbs.	\$ 81.00	Y
HGRSTPGNG18	18" Thermopile & Pilot Burner for MV System NG	1 lbs.	\$ 128.00	Y
HGRSTPGLP18	18" Thermopile & Pilot Burner for MV System LP	1 lbs.	\$ 128.00	Y
HGRSTPGNG48	48" Thermopile & Pilot Burner for MV System NG	1 lbs.	\$ 139.00	Y
HGRSTPGLP48	48" Thermopile & Pilot Burner for MV System LP	1 lbs.	\$ 139.00	N

Remote Controls and Switching Accessories

Item Code	Item Name	Ship Weight	Retail Price	Stocked
Remote Control Receiver Heat Shield				
HGFRCHSCL	Remote Control Receiver Heat Shield - Fiber Cover and Base	1 lbs.	\$ 57.00	Y

Electronic Ignition (On/Off) Systems (Vented Sets)

Item Code	Item Name	Ship Weight	Retail Price	Stocked
Electronic Ignition Pilot Kit				
HGDEIPO	Electronic Ignition Safety Pilot Control - Parts Only	6 lbs.	\$ 626.00	Y

LP Conversion Kits for DEI-PO Electronic Ignition Pilot Controls

Item Code	Item Name	Ship Weight	Retail Price	Stocked
vermiculite, air mixer and pilot orifice included.				
HGDXPCK30	For 30" to 36" Sets (#42 orifice on Air Mixer)	4 lbs.	\$ 106.00	Y

Electronic Ignition (Variable Flame Systems (Vented Sets)

Item Code	Item Name	Ship Weight	Retail Price	Stocked
Parts				
HGAFPM	Hi/Low Power Module	1 lbs.	\$ 76.00	N

Stock: Y = Stock, N or * = Non-Stock, LTSD = Limited to Stock on Hand

Non-Stock Item Notice: Items marked non-stock must be ordered in case quantities

Hargrove Gas Logs (Vented)

Control System Concealer (CSC)



2
0
2
5
-
2
0
2
6

Control System Concealer (CSC)

Variable Flame Electronic Ignition with Remote Control ~ The Control System Concealer (CSC) is a false floor that hides a variable flame electronic ignition system underneath ~ It stands 2.5" tall and can be ordered as a parts-only kit and paired with a match light (see "Pilot Kits with Floor") set or ordered as a complete kit (see "Full Burner Kits") in NG or LP

Item Code	Item Name	Ship Weight	Retail Price	Stocked
Pilot Kits with Floor (Variable Flame Remote, NG)				
HG18NMXRRC	30"(Front) x 17" (Back) x 12.5" (Depth) - MUST ADD MATCH LIGHT ACCESSORY KIT - NG	-	\$ 1,105.00	N
HG24NMXRRC	36"(Front) x 23" (Back) x 12.5" (Depth) - MUST ADD MATCH LIGHT ACCESSORY KIT - NG	-	\$ 1,133.00	Y
HG30NMXRRC	42"(Front) x 29" (Back) x 12.5" (Depth) - MUST ADD MATCH LIGHT ACCESSORY KIT - NG	-	\$ 1,161.00	N
HG36NMXRRC	48"(Front) x 35" (Back) x 12.5" (Depth) - MUST ADD MATCH LIGHT ACCESSORY KIT - NG	-	\$ 1,191.00	N
<i>with Bluetooth Smart Receiver - Add "BT" to end of SKU and \$260 Up Charge</i>				
Full Burner Kits with Floor - "Ember Burner" (Variable Flame Remote, NG)				
HG18CNEB3X5	Ember Burner - 30"(Front) x 17" (Back) x 12.5" (Depth) - NG	-	\$ 1,424.00	Y
HG24CNEB3X5	Ember Burner - 36"(Front) x 23" (Back) x 12.5" (Depth) - NG	-	\$ 1,484.00	N
HG30CNEB3X5	Ember Burner - 42"(Front) x 29" (Back) x 12.5" (Depth) - NG	-	\$ 1,562.00	N
HG36CNEB3X5	Ember Burner - 48"(Front) x 35" (Back) x 12.5" (Depth) - NG	-	\$ 1,700.00	Y
<i>with Bluetooth Smart Receiver - Add "BT" to end of SKU and \$260 Up Charge</i>				
Full Burner Kits with Floor - "Ember Burner" (Variable Flame Remote, LP)				
HG18CPEB3X5	Ember Burner - 30"(Front) x 17" (Back) x 12.5" (Depth) - LP	-	\$ 1,457.00	N
HG24CPEB3X5	Ember Burner - 36"(Front) x 23" (Back) x 12.5" (Depth) - LP	-	\$ 1,517.00	Y
HG30CPEB3X5	Ember Burner - 42"(Front) x 29" (Back) x 12.5" (Depth) - LP	-	\$ 1,595.00	Y
HG36CPEB3X5	Ember Burner - 48"(Front) x 35" (Back) x 12.5" (Depth) - LP	-	\$ 1,733.00	Y
<i>with Bluetooth Smart Receiver - Add "BT" to end of SKU and \$260 Up Charge</i>				
Full Burner Kits with Floor - "H Burner" (Variable Flame Remote, NG)				
HG18CNHB3X5	H Burner - 30"(Front) x 17" (Back) x 12.5" (Depth) - NG	-	\$ 1,489.00	N
HG24CNHB3X5	H Burner - 36"(Front) x 23" (Back) x 12.5" (Depth) - NG	-	\$ 1,547.00	Y
HG30CNHB3X5	H Burner - 42"(Front) x 29" (Back) x 12.5" (Depth) - NG	-	\$ 1,626.00	Y
HG36CNHB3X5	H Burner - 48"(Front) x 35" (Back) x 12.5" (Depth) - NG	-	\$ 1,766.00	N
<i>with Bluetooth Smart Receiver - Add "BT" to end of SKU and \$260 Up Charge</i>				
Full Burner Kits with Floor - "H Burner" (Variable Flame Remote, LP)				
HG18CPHB3X5	H Burner - 30"(Front) x 17" (Back) x 12.5" (Depth) - LP	-	\$ 1,503.00	N
HG24CPHB3X5	H Burner - 36"(Front) x 23" (Back) x 12.5" (Depth) - LP	-	\$ 1,561.00	N
HG30CPHB3X5	H Burner - 42"(Front) x 29" (Back) x 12.5" (Depth) - LP	-	\$ 1,640.00	N
HG36CPHB3X5	H Burner - 48"(Front) x 35" (Back) x 12.5" (Depth) - LP	-	\$ 1,780.00	N
<i>with Bluetooth Smart Receiver - Add "BT" to end of SKU and \$260 Up Charge</i>				
Full Burner Kits with Floor - "4 Floor" (Variable Flame Remote, LP)				
HG18CPSF3X5	4 Floor - 30"(Front) x 17" (Back) x 12.5" (Depth) - LP	-	\$ 1,688.00	N
HG24CPSF3X5	4 Floor - 36"(Front) x 23" (Back) x 12.5" (Depth) - LP	-	\$ 1,753.00	Y
HG30CPSF3X5	4 Floor - 42"(Front) x 29" (Back) x 12.5" (Depth) - LP	-	\$ 1,818.00	N
HG36CPSF3X5	4 Floor - 48"(Front) x 35" (Back) x 12.5" (Depth) - LP	-	\$ 2,354.00	N
<i>with Bluetooth Smart Receiver - Add "BT" to end of SKU and \$260 Up Charge</i>				
LP Conversion Kits (for use with "Ember Burner" Control System Concealer)				
<i>Converts single sided Ember Burner from NG to LP Operation - Includes Vermiculite, Air Mixer and Pilot Orifice</i>				
HGMEIPCK18	for 15" - 27" Sets (#48 Orifice on Air Mixer)	-	\$ 94.00	N
HGMEIPCK30	for 30" - 36" Sets (#38 Orifice on Air Mixer)	-	\$ 94.00	N



Control System Concealer
(Logs Not Included)

Gas Logs

Hargrove Gas Logs (Vented)
Replacement (Refractory, Individual Logs and Parts)



Replacement Refractory Panels

Item Code	Item Name	Ship Weight	Retail Price	Stocked
HGU2428	Universal Refractory Panel 24" x 28" - 1" Thick - In Qty's of 1-29	35 lbs.	\$ 206.13	Y
HGU2440	Universal Refractory Panel 24" x 40" - 1" Thick - In Qty's of 1-29	55 lbs.	\$ 230.04	Y

Individual Logs

Item Code	Item Name	Ship Weight	Retail Price	Stocked
Cross Timbers				
HGF2522GO	21"	3 lbs.	\$ 141.00	Y
Blazing Pecan				
HG2511GO	14"	5 lbs.	\$ 76.00	N
Grand Oak				
HG0118GO	18"	12 lbs.	\$ 103.00	Y
HG0119GO	18"	15 lbs.	\$ 107.00	Y
HG0124GO	24"	25 lbs.	\$ 200.00	Y
HG0128GO	28"	22 lbs.	\$ 180.00	Y
Western Pine				
HG1524GO	24"	20 lbs.	\$ 214.00	N

Parts

Item Code	Item Name	Ship Weight	Retail Price	Stocked
Ember Enhancing System				
HGEM	Ember Wool - Vermiculite and Rock Wool, EM	1 lbs.	\$ 25.84	Y
Pedestal Grate Facing				
HGPGF18	Cast iron facing for 18"-21" vented sets - 18"-21" vent free sets	5 lbs.	\$ 62.00	Y
Bark, Chip, Twig and Pine Kits				
HGCK6	4 - Bark Chips, 1 = Pine Cone #1203, 1 = Twig #0605GO	9 lbs.	\$ 84.00	Y
HGCCKGO	4 - Decorative Charred Chips for Ember Bed	2 lbs.	\$ 64.00	Y
HGDPC2	2 - Decorative Pine Cones - #1201, #1203	3 lbs.	\$ 41.00	Y
Pine Cones and Acorns				
HG1201BX	Small	1 lbs.	\$ 25.00	Y
HG1202BX	Small	1 lbs.	\$ 25.00	Y
HG1203BX	Small	1 lbs.	\$ 25.00	Y
HG1204BX	Small	1 lbs.	\$ 25.00	Y
HG1205BX	Medium	2 lbs.	\$ 28.00	Y
HGAR3CL	Cluster of 3 Acorns	1 lbs.	\$ 12.00	Y
Burner Pan Media				
HGRW	Glowing Embers	1 lbs.	\$ 35.00	Y
HGPB5	Platinum Bright Embers - 5 Gram Bag	1 lbs.	\$ 68.00	Y
HGVM	Vermiculite - 1 lb. Bag	1 lbs.	\$ 33.00	Y
Manual Valves				
HGJCAPO	Gas Valve w/Knob - Rated 300 F	2 lbs.	\$ 76.00	Y
Misc. Parts				
HGLOGBURNDISPLA	(HGBURNINGDISPLAY) BURNING DISPLAY, LOG BURN DISPLAY	100 lbs.	\$ 365.56	Y
HGDS	Damper Stop	1 lbs.	\$ 5.00	Y
HGFNCW18	Stainless Non-Harmonic Flex Conn. - 3/8" OD X 18", Vented Sets	1 lbs.	\$ 28.00	Y

Stock: Y = Stock, N or * = Non-Stock, LTSD = Limited to Stock on Hand

Non-Stock Item Notice: Items marked non-stock must be ordered in case quantities

Gas Logs

Hargrove Gas Logs (Vent-Free)
Cimarron Timbers Logs and Switching Accessories



2
0
2
5
-
2
0
2
6

Cimarron Timbers Vent-Free

Item Code	Item Name	Ship Weight	Retail Price	Stocked
Millivolt Valve - NG				
HGRGCI24N2C	24" Cimarron Timbers with Millivolt Valve; Remote <i>Ready</i> , NG NEW	62 lbs.	\$ 1,583.00	TBD
HGRGCI30N2C	30" Cimarron Timbers with Millivolt Valve; Remote <i>Ready</i> , NG NEW	75 lbs.	\$ 1,654.00	TBD
Millivolt Valve - LP				
HGRGCI24P2C	24" Cimarron Timbers with Millivolt Valve; Remote <i>Ready</i> , LP NEW	62 lbs.	\$ 1,583.00	TBD
HGRGCI30P2C	30" Cimarron Timbers with Millivolt Valve; Remote <i>Ready</i> , LP NEW	75 lbs.	\$ 1,654.00	TBD
Variable Flame Valve - NG				
HGRGCI24N1E	24" Cimarron Timbers with Variable Flame Valve; Remote <i>Ready</i> , NG NEW	62 lbs.	\$ 1,666.00	TBD
HGRGCI30N1E	30" Cimarron Timbers with Variable Flame Valve; Remote <i>Ready</i> , NG NEW	75 lbs.	\$ 1,737.00	TBD
Variable Flame Valve - LP				
HGRGCI24P1E	24" Cimarron Timbers with Variable Flame Valve; Remote <i>Ready</i> , LP NEW	62 lbs.	\$ 1,666.00	TBD
HGRGCI30P1E	30" Cimarron Timbers with Variable Flame Valve; Remote <i>Ready</i> , LP NEW	75 lbs.	\$ 1,737.00	TBD
Electronic Ignition Valve - NG				
HGRGCI24N3E	24" Cimarron Timbers with Electronic Ignition Valve; <i>Includes Variable Remote</i> , NG NEW	62 lbs.	\$ 2,142.00	TBD
HGRGCI30N3E	30" Cimarron Timbers with Electronic Ignition Valve; <i>Includes Variable Remote</i> , NG NEW	75 lbs.	\$ 2,213.00	TBD
Electronic Ignition Valve - LP				
HGRGCI24P3E	24" Cimarron Timbers with Electronic Ignition Valve; <i>Includes Variable Remote</i> , LP NEW	62 lbs.	\$ 2,142.00	TBD
HGRGCI30P3E	30" Cimarron Timbers with Electronic Ignition Valve; <i>Includes Variable Remote</i> , LP NEW	75 lbs.	\$ 2,213.00	TBD



Cimarron Timbers

Cimarron Timbers Switching Accessories

Item Code	Item Name	Ship Weight	Retail Price	Stocked
Millivolt (Vent-Free) Remote Control & Switching Accessories				
HGRCS12VMV	Kit Includes 12 VDC Remote/Receiver - Remote Features: On/Off Function	1 lbs.	\$ 124.00	Y
HGRCI12VBT	Kit Includes 12VDC Remote/Receiver & Bluetooth Smart Phone Capability NEW	1 lbs.	\$ 270.00	TBD
HGBTIBUG	Includes Bluetooth Module Control for Smart Phone Capability NEW	1 lbs.	\$ 190.00	TBD
HGRCS12VMVT	Thermostatic On/Off Function	1 lbs.	\$ 203.00	N
HGRCS301P	Thermostatic, Programmable, Full LCD Touchscreen Display	1 lbs.	\$ 345.00	N
HGRCA110VA	Requires 110 Volt A/C Electricity - Remote Features: On/Off Function, Child-Proof Switch	1 lbs.	\$ 211.00	N
HGTST	Wall Mount Thermostat Control (not recommended for vented sets)	1 lbs.	\$ 59.00	N
HGBCS	Bark Chip Switch, On/Off Function	1 lbs.	\$ 29.00	Y
HGPCS	2 Piece Pine Cone Switch, On/Off Function	2 lbs.	\$ 35.00	N
HGWS	Wall Switch, On/Off Function	1 lbs.	\$ 29.00	N
Variable Flame (Vent-Free) Remote Control & Switching Accessories				
HGRCS6VMX	DC Powered Remote/Receiver for Variable Flame System Valves	1 lbs.	\$ 204.00	Y
HGRCS6VMXT	DC Powered Remote/Receiver for Variable Flame Valves, w/Thermostat (Not Recommended for Vented Sets)	1 lbs.	\$ 271.00	N
HGRCR300	Remote/Receiver for Variable Flame Systems, Full LCD Display, Thermostatic and Child Safety Lock	1 lbs.	\$ 345.00	N
Electronic Ignition (Vent-Free) Remote Control & Switching Accessories				
HGBTMEIMOD	Includes Bluetooth Module Control for Smart Phone Capability NEW	1 lbs.	\$ 316.00	TBD

Gas Logs

Hargrove Gas Logs (Vent-Free)
 Birch Timbers Logs and Switching Accessories



Birch Timbers Vent-Free				
Item Code	Item Name	Ship Weight	Retail Price	Stocked
Millivolt Valve - NG				
HGRGBI24N2C	24" Birch Timbers with Millivolt Valve; Remote <i>Ready</i> , NG NEW	62 lbs.	\$ 1,653.00	TBD
HGRGBI30N2C	30" Birch Timbers with Millivolt Valve; Remote <i>Ready</i> , NG NEW	75 lbs.	\$ 1,735.00	TBD
Millivolt Valve - LP				
HGRGBI24P2C	24" Birch Timbers with Millivolt Valve; Remote <i>Ready</i> , LP NEW	62 lbs.	\$ 1,653.00	TBD
HGRGBI30P2C	30" Birch Timbers with Millivolt Valve; Remote <i>Ready</i> , LP NEW	75 lbs.	\$ 1,735.00	TBD
Variable Flame Valve - NG				
HGRGBI24N1E	24" Birch Timbers with Variable Flame Valve; Remote <i>Ready</i> , NG NEW	62 lbs.	\$ 1,736.00	TBD
HGRGBI30N1E	30" Birch Timbers with Variable Flame Valve; Remote <i>Ready</i> , NG NEW	75 lbs.	\$ 1,818.00	TBD
Variable Flame Valve - LP				
HGRGBI24P1E	24" Birch Timbers with Variable Flame Valve; Remote <i>Ready</i> , LP NEW	62 lbs.	\$ 1,736.00	TBD
HGRGBI30P1E	30" Birch Timbers with Variable Flame Valve; Remote <i>Ready</i> , LP NEW	75 lbs.	\$ 1,818.00	TBD
Electronic Ignition Valve - NG				
HGRGBI24N3E	24" Birch Timbers with Electronic Ignition Valve; <i>Includes Variable Remote</i> , NG NEW	62 lbs.	\$ 2,213.00	TBD
HGRGBI30N3E	30" Birch Timbers with Electronic Ignition Valve; <i>Includes Variable Remote</i> , NG NEW	75 lbs.	\$ 2,294.00	TBD
Electronic Ignition Valve - LP				
HGRGBI24P3E	24" Birch Timbers with Electronic Ignition Valve; <i>Includes Variable Remote</i> , LP NEW	62 lbs.	\$ 2,313.00	TBD
HGRGBI30P3E	30" Birch Timbers with Electronic Ignition Valve; <i>Includes Variable Remote</i> , LP NEW	75 lbs.	\$ 2,294.00	TBD



Birch Timbers

Birch Timbers Switching Accessories				
Item Code	Item Name	Ship Weight	Retail Price	Stocked
Millivolt (Vent-Free) Remote Control & Switching Accessories				
HGRCS12VMV	Kit Includes 12 VDC Remote/Receiver - Remote Features: On/Off Function	1 lbs.	\$ 124.00	Y
HGRCI12VBT	Kit Includes 12VDC Remote/Receiver & Bluetooth Smart Phone Capability NEW	1 lbs.	\$ 270.00	TBD
HGBTIBUG	Includes Bluetooth Module Control for Smart Phone Capability NEW	1 lbs.	\$ 190.00	TBD
HGRCS12VMVT	Thermostatic On/Off Function	1 lbs.	\$ 203.00	N
HGRCS301P	Thermostatic, Programmable, Full LCD Touchscreen Display	1 lbs.	\$ 345.00	N
HGRCA110VA	Requires 110 Volt A/C Electricity - Remote Features: On/Off Function, Child-Proof Switch	1 lbs.	\$ 211.00	N
HGTST	Wall Mount Thermostat Control (not recommended for vented sets)	1 lbs.	\$ 59.00	N
HGBCS	Bark Chip Switch, On/Off Function	1 lbs.	\$ 29.00	Y
HGPCS	2 Piece Pine Cone Switch, On/Off Function	2 lbs.	\$ 35.00	N
HGWS	Wall Switch, On/Off Function	1 lbs.	\$ 29.00	N
Variable Flame (Vent-Free) Remote Control & Switching Accessories				
HGRCS6VMX	DC Powered Remote/Receiver for Variable Flame System Valves	1 lbs.	\$ 204.00	Y
HGRCS6VMXT	DC Powered Remote/Receiver for Variable Flame Valves, w/Thermostat (Not Recommended for Vented Sets)	1 lbs.	\$ 271.00	N
HGRRCR300	Remote/Receiver for Variable Flame Systems, Full LCD Display, Thermostatic and Child Safety Lock	1 lbs.	\$ 345.00	N
Electronic Ignition (Vent-Free) Remote Control & Switching Accessories				
HGBTMEIIMOD	Includes Bluetooth Module Control for Smart Phone Capability NEW	1 lbs.	\$ 316.00	TBD

Stock: Y = Stock, N or * = Non-Stock, LTSD = Limited to Stock on Hand

Non-Stock Item Notice: Items marked non-stock must be ordered in case quantities

Gas Logs

Hargrove Gas Logs (Vent-Free)
Yukon Char Logs and Switching Accessories



2
0
2
5
-
2
0
2
6

Yukon Char Vent-Free					
Item Code	Item Name	Ship Weight	Retail Price	Stocked	
Manual Valve - NG					
HGETYC18N1G	18" Yukon Char w/Manual Valve, NG	50 lbs.	\$ 1,069.00	N	
HGETYC24N1G	24" Yukon Char w/Manual Valve, NG	62 lbs.	\$ 1,099.00	N	
HGETYC30N1G	30" Yukon Char w/Manual Valve, NG	75 lbs.	\$ 1,132.00	N	
Millivolt Valve - NG					
HGETYC18N2C	18" Yukon Char w/Millivolt Valve, Remote Ready, NG	50 lbs.	\$ 1,363.00	Y	
HGETYC24N2C	24" Yukon Char w/Millivolt Valve, Remote Ready, NG	62 lbs.	\$ 1,395.00	Y	
HGETYC30N2C	30" Yukon Char w/Millivolt Valve, Remote Ready, NG	75 lbs.	\$ 1,426.00	Y	
Variable Flame Valve - NG					
HGETYC18N1E	18" Yukon Char w/Variable Flame Valve, Remote Ready, NG	50 lbs.	\$ 1,480.00	N	
HGETYC24N1E	24" Yukon Char w/Variable Flame Valve, Remote Ready, NG	62 lbs.	\$ 1,509.00	Y	
HGETYC30N1E	30" Yukon Char w/Variable Flame Valve, Remote Ready, NG	75 lbs.	\$ 1,541.00	N	
Manual Valve - LP					
HGETYC18P1G	18" Yukon Char w/Manual Valve, LP	50 lbs.	\$ 1,069.00	N	
HGETYC24P1G	24" Yukon Char w/Manual Valve, LP	62 lbs.	\$ 1,099.00	N	
HGETYC30P1G	30" Yukon Char w/Manual Valve, LP	75 lbs.	\$ 1,132.00	N	
Millivolt Valve - LP					
HGETYC18P2C	18" Yukon Char w/Millivolt Valve, Remote Ready, NG	50 lbs.	\$ 1,363.00	Y	
HGETYC24P2C	24" Yukon Char w/Millivolt Valve, Remote Ready, NG	62 lbs.	\$ 1,395.00	Y	
HGETYC30P2C	30" Yukon Char w/Millivolt Valve, Remote Ready, NG	75 lbs.	\$ 1,426.00	Y	
Variable Flame Valve - LP					
HGETYC18P1E	18" Yukon Char w/Variable Flame Valve, Remote Ready, LP	50 lbs.	\$ 1,480.00	N	
HGETYC24P1E	24" Yukon Char w/Variable Flame Valve, Remote Ready, LP	62 lbs.	\$ 1,509.00	Y	
HGETYC30P1E	30" Yukon Char w/Variable Flame Valve, Remote Ready, LP	75 lbs.	\$ 1,541.00	N	



Yukon Char

Yukon Char Switching Accessories					
Item Code	Item Name	Ship Weight	Retail Price	Stocked	
Millivolt (Vent-Free) Remote Control & Switching Accessories					
HGRCS12VMV	Kit Includes 12 VDC Remote/Receiver - Remote Features: On/Off Function	1 lbs.	\$ 124.00	Y	
HGRCI12VBT	Kit Includes 12VDC Remote/Receiver & Bluetooth Smart Phone Capability NEW	1 lbs.	\$ 270.00	TBD	
HGBTIBUG	Includes Bluetooth Module Control for Smart Phone Capability NEW	1 lbs.	\$ 190.00	TBD	
HGRCS12VMVT	Thermostatic On/Off Function	1 lbs.	\$ 203.00	N	
HGRCS301P	Thermostatic, Programmable, Full LCD Touchscreen Display	1 lbs.	\$ 345.00	N	
HGRCA110VA	Requires 110 Volt A/C Electricity - Remote Features: On/Off Function, Child-Proof Switch	1 lbs.	\$ 211.00	N	
HGTST	Wall Mount Thermostat Control	1 lbs.	\$ 59.00	N	
HGBCS	Bark Chip Switch, On/Off Function	1 lbs.	\$ 29.00	Y	
HGPCS	2 Piece Pine Cone Switch, On/Off Function	2 lbs.	\$ 35.00	N	
HGWS	Wall Switch, On/Off Function	1 lbs.	\$ 29.00	N	
Variable Flame (Vent-Free) Remote Control & Switching Accessories					
HGRCS6VMX	DC Powered Remote/Receiver for Variable Flame System Valves	1 lbs.	\$ 204.00	Y	
HGRCS6VMXT	DC Powered Remote/Receiver for Variable Flame Valves, w/Thermostat (Not Recommended for Vented Sets)	1 lbs.	\$ 271.00	N	
HGRCR300	Remote/Receiver for Variable Flame Systems, Full LCD Display, Thermostatic and Child Safety Lock	1 lbs.	\$ 345.00	N	
Electronic Ignition (Vent-Free) Remote Control & Switching Accessories					
HGBTMEIIMOD	Includes Bluetooth Module Control for Smart Phone Capability NEW	1 lbs.	\$ 316.00	TBD	

Gas Logs

Hargrove Gas Logs (Vent-Free)
Heritage Char Logs and Switching Accessories



Heritage Char Vent-Free

Item Code	Item Name	Ship Weight	Retail Price	Stocked
Manual Valve - NG				
HGETHC18N1G	18" Heritage Char w/Manual Valve, NG	50 lbs.	\$ 1,049.00	N
HGETHC24N1G	24" Heritage Char w/Manual Valve, NG	62 lbs.	\$ 1,077.00	N
HGETHC30N1G	30" Heritage Char w/Manual Valve, NG	75 lbs.	\$ 1,109.00	N
Millivolt Valve - NG				
HGETHC18N2C	18" Heritage Char w/Millivolt Valve, Remote Ready, NG	50 lbs.	\$ 1,337.00	N
HGETHC24N2C	24" Heritage Char w/Millivolt Valve, Remote Ready, NG	62 lbs.	\$ 1,366.00	N
HGETHC30N2C	30" Heritage Char w/Millivolt Valve, Remote Ready, NG	75 lbs.	\$ 1,398.00	N
Variable Flame Valve - NG				
HGETHC18N1E	18" Heritage Char w/Variable Flame Valve, Remote Ready, NG	50 lbs.	\$ 1,453.00	N
HGETHC24N1E	24" Heritage Char w/Variable Flame Valve, Remote Ready, NG	62 lbs.	\$ 1,480.00	N
HGETHC30N1E	30" Heritage Char w/Variable Flame Valve, Remote Ready, NG	75 lbs.	\$ 1,509.00	N
Manual Valve - LP				
HGETHC18P1G	18" Heritage Char w/Manual Valve, LP	50 lbs.	\$ 1,049.00	N
Manual Valve - LP				
HGETHC24P1G	24" Heritage Char w/Manual Valve, LP	62 lbs.	\$ 1,077.00	N
HGETHC30P1G	30" Heritage Char w/Manual Valve, LP	75 lbs.	\$ 1,109.00	N
Millivolt Valve - NG				
HGETHC18P2C	18" Heritage Char w/Millivolt Valve, Remote Ready, NG	50 lbs.	\$ 1,337.00	N
HGETHC24P2C	24" Heritage Char w/Millivolt Valve, Remote Ready, NG	62 lbs.	\$ 1,366.00	N
HGETHC30P2C	30" Heritage Char w/Millivolt Valve, Remote Ready, NG	75 lbs.	\$ 1,398.00	N
Variable Flame Valve - LP				
HGETHC18P1E	18" Heritage Char w/Variable Flame Valve, Remote Ready, LP	50 lbs.	\$ 1,453.00	N
HGETHC24P1E	24" Heritage Char w/Variable Flame Valve, Remote Ready, LP	62 lbs.	\$ 1,480.00	N
HGETHC30P1E	30" Heritage Char w/Variable Flame Valve, Remote Ready, LP	75 lbs.	\$ 1,509.00	N



Heritage Char

Heritage Char Switching Accessories

Item Code	Item Name	Ship Weight	Retail Price	Stocked
Millivolt (Vent-Free) Remote Control & Switching Accessories				
HGRCS12VMV	Kit Includes 12 VDC Remote/Receiver - Remote Features: On/Off Function	1 lbs.	\$ 124.00	Y
HGRCI12VBT	Kit Includes 12VDC Remote/Receiver & Bluetooth Smart Phone Capability NEW	1 lbs.	\$ 270.00	TBD
HGBTIBUG	Includes Bluetooth Module Control for Smart Phone Capability NEW	1 lbs.	\$ 190.00	TBD
HGRCS12VMVT	Thermostatic On/Off Function	1 lbs.	\$ 203.00	N
HGRCS301P	Thermostatic, Programmable, Full LCD Touchscreen Display	1 lbs.	\$ 345.00	N
HGRCA110VA	Requires 110 Volt A/C Electricity - Remote Features: On/Off Function, Child-Proof Switch	1 lbs.	\$ 211.00	N
HGTST	Wall Mount Thermostat Control (Not Recommended for Vented Sets)	1 lbs.	\$ 59.00	N
HGBCS	Bark Chip Switch, On/Off Function	1 lbs.	\$ 29.00	Y
HGPCS	2 Piece Pine Cone switch, On/Off Function	2 lbs.	\$ 35.00	N
HGWS	Wall Switch, On/Off Function	1 lbs.	\$ 29.00	N
Variable Flame (Vent-Free) Remote Control & Switching Accessories				
HGRCS6VMX	DC Powered Remote/Receiver for Variable Flame System Valves	1 lbs.	\$ 204.00	Y
HGRCS6VMXT	DC Powered Remote/Receiver for Variable Flame Valves, w/Thermostat (Not Recommended for Vented Sets)	1 lbs.	\$ 271.00	N
HGRRCR300	Remote/Receiver for Variable Flame Systems, Full LCD Display, Thermostatic and Child Safety Lock	1 lbs.	\$ 345.00	N
Electronic Ignition (Vent-Free) Remote Control & Switching Accessories				
HGBTMEIIMOD	Includes Bluetooth Module Control for Smart Phone Capability NEW	1 lbs.	\$ 316.00	TBD

Stock: Y = Stock, N or * = Non-Stock, LTSD = Limited to Stock on Hand

Non-Stock Item Notice: Items marked non-stock must be ordered in case quantities

Gas Logs

Hargrove Gas Logs (Vent-Free)
Charleston Glow Logs and Switching Accessories



2
0
2
5
-
2
0
2
6

Charleston Glow Vent Free

Item Code	Item Name	Ship Weight	Retail Price	Stocked
Manual Valve - NG				
HGEFCG22N1G	22" Charleston Glow w/Manual Valve, NG	25 lbs.	\$ 999.00	N
HGEFCG26N1G	26" Charleston Glow w/Manual Valve, NG	30 lbs.	\$ 1,028.00	N
Millivolt Valve - NG				
HGEFCG22N2C	22" Charleston Glow w/Millivolt Valve, Remote Ready, NG	25 lbs.	\$ 1,292.00	Y
HGEFCG26N2C	26" Charleston Glow w/Millivolt Valve, Remote Ready, NG	30 lbs.	\$ 1,320.00	Y
Variable Flame Valve - NG				
HGEFCG22N1E	22" Charleston Glow w/Variable Flame Valve, Remote Ready, NG	25 lbs.	\$ 1,411.00	N
HGEFCG26N1E	26" Charleston Glow w/Variable Flame Valve, Remote Ready, NG	30 lbs.	\$ 1,439.00	N
Manual Valve - LP				
HGEFCG22P1G	22" Charleston Glow w/Manual Valve, LP	25 lbs.	\$ 999.00	N
HGEFCG26P1G	26" Charleston Glow w/Manual Valve, LP	30 lbs.	\$ 1,028.00	N
Millivolt Valve - LP				
HGEFCG22P2C	22" Charleston Glow w/Millivolt Valve, Remote Ready, LP	25 lbs.	\$ 1,292.00	Y
HGEFCG26P2C	26" Charleston Glow w/Millivolt Valve, Remote Ready, LP	30 lbs.	\$ 1,320.00	N
Variable Flame Valve - LP				
HGEFCG22P1E	22" Charleston Glow w/Variable Flame Valve, Remote Ready, LP	25 lbs.	\$ 1,411.00	N
HGEFCG26P1E	26" Charleston Glow w/Variable Flame Valve, Remote Ready, LP	30 lbs.	\$ 1,439.00	Y



Charleston Glow

Charleston Glow Switching Accessories

Item Code	Item Name	Ship Weight	Retail Price	Stocked
Millivolt (Vent-Free) Remote Control & Switching Accessories				
HGRCS12VMV	Kit Includes 12 VDC Remote/Receiver - Remote Features: On/Off Function	1 lbs.	\$ 124.00	Y
HGRCI12VBT	Kit Includes 12VDC Remote/Receiver & Bluetooth Smart Phone Capability NEW	1 lbs.	\$ 270.00	TBD
HGBTIBUG	Includes Bluetooth Module Control for Smart Phone Capability NEW	1 lbs.	\$ 190.00	TBD
HGRCS12VMVT	Thermostatic On/Off Function	1 lbs.	\$ 203.00	N
HGRCS301P	Thermostatic, Programmable, Full LCD Touchscreen Display	1 lbs.	\$ 345.00	N
HGRCA110VA	Requires 110 Volt A/C Electricity - Remote Features: On/Off Function, Child-Proof Switch	1 lbs.	\$ 211.00	N
HGTST	Wall Mount Thermostat Control (Not Recommended for Vented Sets)	1 lbs.	\$ 59.00	N
HGBCS	Bark Chip Switch, On/Off Function	1 lbs.	\$ 29.00	Y
HGPCS	2 Piece Pine Cone Switch, On/Off Function	2 lbs.	\$ 35.00	N
HGWS	Wall Switch, On/Off Function	1 lbs.	\$ 29.00	N
Variable Flame (Vent-Free) Remote Control & Switching Accessories				
HGRCS6VMX	DC Powered Remote/Receiver for Variable Flame System Valves	1 lbs.	\$ 204.00	Y
HGRCS6VMXT	DC Powered Remote/Receiver for Variable Flame Valves w/Thermostat (Not Recommended for Vented Sets)	1 lbs.	\$ 271.00	N
HGRCR300	Remote/Receiver for Variable Flame Systems, Full LCD Display, Thermostatic and Child Safety Lock	1 lbs.	\$ 345.00	N
Electronic Ignition (Vent-Free) Remote Control & Switching Accessories				
HGBTMEIIMOD	Includes Bluetooth Module Control for Smart Phone Capability NEW	1 lbs.	\$ 316.00	TBD

Gas Logs

Hargrove Gas Logs (Vent-Free)
 Element Series Logs, Switching Accessories and Media



Element Series Vent Free

Item Code	Item Name	Ship Weight	Retail Price	Stocked
Millivolt Valve - NG				
HGESCS18N2C	18" Element Series w/Millivolt Valve, Remote Ready, NG	11 lbs.	\$ 1,246.00	N
HGESCS24N2C	24" Element Series w/Millivolt Valve, Remote Ready, NG	13 lbs.	\$ 1,321.00	N
HGESCS30N2C	30" Element Series w/Millivolt Valve, Remote Ready, NG	15 lbs.	\$ 1,395.00	N
Millivolt Valve - LP				
HGESCS18P2C	18" Element Series w/Millivolt Valve, Remote Ready, LP	11 lbs.	\$ 1,246.00	N
HGESCS24P2C	24" Element Series w/Millivolt Valve, Remote Ready, LP	13 lbs.	\$ 1,321.00	N
HGESCS30P2C	30" Element Series w/Millivolt Valve, Remote Ready, LP	15 lbs.	\$ 1,395.00	N

Element Series Switching Accessories

Item Code	Item Name	Ship Weight	Retail Price	Stocked
Millivolt (Vent-Free) Remote Control & Switching Accessories				
HGRCS12VMV	Kit Includes 12 VDC Remote/Receiver - Remote Features: On/Off Function	1 lbs.	\$ 124.00	Y
HGRCI12VBT	Kit Includes 12VDC Remote/Receiver & Bluetooth Smart Phone Capability NEW	1 lbs.	\$ 270.00	TBD
HGBTIBUG	Includes Bluetooth Module Control for Smart Phone Capability NEW	1 lbs.	\$ 190.00	TBD
HGRCS12VMVT	Thermostatic On/Off Function	1 lbs.	\$ 203.00	N
HGRCS301P	Thermostatic, Programmable, Full LCD Touchscreen Display	1 lbs.	\$ 345.00	N
HGRCA110VA	Requires 110 Volt A/C Electricity - Remote Features: On/Off Function, Child-Proof Switch	1 lbs.	\$ 211.00	N
HGTST	Wall Mount Thermostat Control	1 lbs.	\$ 59.00	N
HGBCS	Bark Chip Switch, On/Off Function	1 lbs.	\$ 29.00	Y
HGPCS	2 Piece Pine Cone Switch, On/Off Function	2 lbs.	\$ 35.00	N
HGWS	Wall Switch, On/Off Function	1 lbs.	\$ 29.00	N



Twig Set for
Element Series



Glass for
Element Series



River Stones for
Element Series

Media Options for Element Series

Item Code	Item Name	Ship Weight	Retail Price	Stocked
Fireglass				
HGBKN10FG	(HGQMBR1010) Non-Reflective Midnight Black 1/4" Fireglass (10 lb. bag)	10 lbs.	\$ 88.50	N
HGBLN10FG	(HGQPR10) Non-Reflective Blue Lagoon 1/4" Fireglass (10 lb. bag)	10 lbs.	\$ 88.50	N
Element 24" w/Blazing River Stones				
HGESRRK18	18" Multi-Colored Set	15 lbs.	\$ 168.00	N
HGESRRK24	24" Multi-Colored Set	20 lbs.	\$ 219.00	N
HGESRRK30	30" Multi-Colored Set	25 lbs.	\$ 279.00	N
Element 24" w/Aspen Twig Set				
HGESATK18	2 Piece Twig Set	5 lbs.	\$ 70.00	N
HGESATK24	3 Piece Twig Set	8 lbs.	\$ 105.00	N
HGESATK30	4 Piece Twig Set	11 lbs.	\$ 139.00	N
Element 24" w/Driftwood Twig Set				
HGESDTK18	2 Piece Twig Set	6 lbs.	\$ 64.00	N
HGESDTK24	3 Piece Twig Set	7 lbs.	\$ 80.00	N
HGESDTK30	4 Piece Twig Set	11 lbs.	\$ 126.00	N

Stock: Y = Stock, N or * = Non-Stock, LTSD = Limited to Stock on Hand

Non-Stock Item Notice: Items marked non-stock must be ordered in case quantities

Gas Logs

Hargrove Gas Logs (Vent-Free)
Weathered Oak Logs and Switching Accessories



2
0
2
5
-
2
0
2
6

Weathered Oak Vent Free

Item Code	Item Name	Ship Weight	Retail Price	Stocked
Manual Valve - NG				
HGVFWR18N1G	18" Weathered Oak w/Manual Valve, NG	25 lbs.	\$ 526.00	Y
HGVFWR24N1G	24" Weathered Oak w/Manual Valve, NG	30 lbs.	\$ 546.00	N
Millivolt Valve - NG				
HGVFWR18N2C	18" Weathered Oak w/Millivolt Valve, Remote Ready, NG	25 lbs.	\$ 671.00	Y
HGVFWR24N2C	30" Weathered Oak w/Millivolt Valve, Remote Ready, NG	30 lbs.	\$ 691.00	Y
Manual Valve - LP				
HGVFWR18P1G	18" Weathered Oak w/Manual Valve, LP	25 lbs.	\$ 526.00	Y
HGVFWR24P1G	24" Weathered Oak w/Manual Valve, LP	30 lbs.	\$ 546.00	Y
Millivolt Valve - LP				
HGVFWR18P2C	18" Weathered Oak w/Millivolt Valve, Remote Ready, LP	25 lbs.	\$ 671.00	Y
HGVFWR24P2C	24" Weathered Oak w/Millivolt Valve, Remote Ready, LP	30 lbs.	\$ 691.00	Y



Weathered Oak

Weathered Oak Switching Accessories

Item Code	Item Name	Ship Weight	Retail Price	Stocked
Millivolt (Vent-Free) Remote Control & Switching Accessories				
HGRCS12VMV	Kit Includes 12 VDC Remote/Receiver - Remote Features: On/Off Function	1 lbs.	\$ 124.00	Y
HGRCI12VBT	Kit Includes 12VDC Remote/Receiver & Bluetooth Smart Phone Capability NEW	1 lbs.	\$ 270.00	TBD
HGBTIBUG	Includes Bluetooth Module Control for Smart Phone Capability NEW	1 lbs.	\$ 190.00	TBD
HGRCS12VMVT	Thermostatic On/Off Function	1 lbs.	\$ 203.00	N
HGRCS301P	Thermostatic, Programmable, Full LCD Touchscreen Display	1 lbs.	\$ 345.00	N
HGRCA110VA	Requires 110 Volt A/C Electricity - Remote Features: On/Off Function, Child-Proof Switch	1 lbs.	\$ 211.00	N
HGTST	Wall Mount Thermostat Control (Not Recommended for Vented Sets)	1 lbs.	\$ 59.00	N
HGBCS	Bark Chip Switch, On/Off Function	1 lbs.	\$ 29.00	Y
HGPCS	2 Piece Pine Cone switch, On/Off Function	2 lbs.	\$ 35.00	N
HGWS	Wall Switch, On/Off Function	1 lbs.	\$ 29.00	N

Designer Hearth
Accessories



JEWELRY - GLASS			
Large Broken Glass 10lbs. (1/2" - 3/4")			
<i>Item Number</i>	<i>Description</i>	<i>Retail</i>	<i>Stocked</i>
FGGLBLACK10	Pepper (Black) Irregularly Shaped Glass	\$39.99	Y
FGGLCOPPER10	Cola Irregularly Shaped Glass	39.99	Y
FGGLCRYSTAL10	Crystal (Clear) Irregularly Shaped Glass	39.99	Y
FGGLDARKBLUE10	Blueberry (Dark Blue) Irregularly Shaped Glass	39.99	Y
FGGLLIGHTBLUE10	Caribbean/Paradise Blend Irregularly Shaped Glass	39.99	Y
FGGLSEABREEZE10	Seabreeze (Ocean Blue) Irregularly Shaped Glass	39.99	Y
Reflective Broken Glass 10lbs. (1/2" - 3/4")			
FGGRLBLACK10	Black Reflective Fireglass	59.00	Y
FGGRLBRONZE10	Bronze Reflective Fireglass	59.00	Y
FGGRLCOBALT10	Cobalt Reflective Fireglass	59.00	Y
FGGRLCOPPER10	Copper Reflective Fireglass	59.00	TBD
FGGRLSILVER10	Silver Reflective Fireglass	59.00	TBD
LAVA ROCK			
FGLAVA10	10 lb. Bag of 1 to 2" Black Lava Rock	\$29.00	Y
FGLS50	50 lb. Bag of Lava Stones - Ranging from 1 1/2" to 2" Size	199.00	Y

Fireglass Plus
Glass, Accessories & Burners

2
0
2
5
-
2
0
2
6

FireGlass Plus				
Master packs are 4 bags/case.				
Item Code	Item Name	Ship Weight	Retail Price	Stocked
1/4" Non-Reflective Fireglass - 10lb Bag				
FSQG10	1/4" Gunmetal - LIMITED TO STOCK ON HAND	10 lbs.	\$ 47.50	LTSD
FSQCB10	1/4" Caribbean Blue - LIMITED TO STOCK ON HAND	10 lbs.	\$ 47.50	LTSD
FSQC10	1/4" Copper - LIMITED TO STOCK ON HAND	10 lbs.	\$ 47.50	LTSD
FSQCI10	1/4" Crystal Ice - LIMITED TO STOCK ON HAND	10 lbs.	\$ 55.00	LTSD
1/4" Reflective Fireglass - 10lb Bag				
FSQBR10	1/4" Bronze Reflective - LIMITED TO STOCK ON HAND	10 lbs.	\$ 55.00	LTSD
FSQER10	1/4" Emerald Reflective - LIMITED TO STOCK ON HAND	10 lbs.	\$ 55.00	LTSD
FSQGR10	1/4" Gunmetal Reflective - LIMITED TO STOCK ON HAND	10 lbs.	\$ 55.00	LTSD
FSQBLR10	1/4" Blue Lagoon Reflective - LIMITED TO STOCK ON HAND	10 lbs.	\$ 55.00	LTSD
FSQCBR10	1/4" Caribbean Blue Reflective - LIMITED TO STOCK ON HAND	10 lbs.	\$ 55.00	LTSD
FSQCR10	1/4" Copper Reflective - LIMITED TO STOCK ON HAND	10 lbs.	\$ 55.00	LTSD
FSQCHR10	1/4" Champagne Reflective - LIMITED TO STOCK ON HAND	10 lbs.	\$ 55.00	LTSD
FSQJR10	1/4" Jade Reflective - LIMITED TO STOCK ON HAND	10 lbs.	\$ 55.00	LTSD
FSQPR10	1/4" Platinum Reflective - LIMITED TO STOCK ON HAND	10 lbs.	\$ 55.00	LTSD
FSQSR10	1/4" Sapphire Reflective - LIMITED TO STOCK ON HAND	10 lbs.	\$ 55.00	LTSD
FSQMBR10	1/4" Midnight Black Reflective - LIMITED TO STOCK ON HAND	10 lbs.	\$ 55.00	LTSD
FSQGRR10	1/4" Goldrush Reflective - LIMITED TO STOCK ON HAND	10 lbs.	\$ 55.00	LTSD
1/2" Reflective Fireglass - 10lb Bag				
FSHC10	1/2" Crystal Ice - LIMITED TO STOCK ON HAND	10 lbs.	\$ 65.00	LTSD
FSHCR10	1/2" Copper Reflective - LIMITED TO STOCK ON HAND	10 lbs.	\$ 65.00	LTSD
FSHBR10	1/2" Bronze Reflective - LIMITED TO STOCK ON HAND	10 lbs.	\$ 65.00	LTSD
FSHMBR10	1/2" Midnight Black Reflective - LIMITED TO STOCK ON HAND	10 lbs.	\$ 65.00	LTSD
FSHSR10	1/2" Sapphire Reflective - LIMITED TO STOCK ON HAND	10 lbs.	\$ 65.00	LTSD
FSHGR10	1/2" Gun Metal Reflective - LIMITED TO STOCK ON HAND	10 lbs.	\$ 65.00	LTSD
FSHPR10	1/2" Platinum Reflective - LIMITED TO STOCK ON HAND	10 lbs.	\$ 65.00	LTSD
FSHBLR10	1/2" Blue Lagoon Reflective - LIMITED TO STOCK ON HAND	10 lbs.	\$ 65.00	LTSD
FSHCBR10	1/2" Caribbean Blue Reflective - LIMITED TO STOCK ON HAND	10 lbs.	\$ 65.00	LTSD
FSHGRR10	1/2" Goldrush Reflective - LIMITED TO STOCK ON HAND	10 lbs.	\$ 65.00	LTSD
1/4" Reflective Fireglass - 10lb Bag				
FSQSB10	Sedona Blend - Rosegold, Bronze and Platinum Reflective - LIMITED TO STOCK ON HAND	10 lbs.	\$ 65.00	LTSD
FSQOB10	Outlaw Blend - Sapphire, Midnight Black and Platinum Reflective - LIMITED TO STOCK ON HAND	10 lbs.	\$ 65.00	LTSD
FSQBB10	Bermuda Blend - Caribbean, Sapphire and Crystal Ice Reflective - LIMITED TO STOCK ON HAND	10 lbs.	\$ 65.00	LTSD
FSQSHB10	Shamrock Blend - Emerald, Midnight Black and Platinum Reflective - LIMITED TO STOCK ON HAND	10 lbs.	\$ 65.00	LTSD
Accessories				
FSFGPOLS10	10 lb. Bag Black Lava - 3/8" - LIMITED TO STOCK ON HAND	10 lbs.	\$ 20.00	LTSD
FSFGPOLM10	10 lb. Bag Black Lava - 1" - LIMITED TO STOCK ON HAND	10 lbs.	\$ 20.00	LTSD
FSFGPBS10	10 lb. Bag Black Sand - LIMITED TO STOCK ON HAND	10 lbs.	\$ 20.00	LTSD
FSFGPRLM20	Rolled Lava 20 lb. Bag 3-5" - LIMITED TO STOCK ON HAND	20 lbs.	\$ 60.00	LTSD
FSFGPRLM50	Rolled Lava 50 lb. Bag 3-5" - LIMITED TO STOCK ON HAND	50 lbs.	\$ 150.00	LTSD
FSFGPRLS20	Rolled Lava 20 lb. Bag 1-2" - LIMITED TO STOCK ON HAND	20 lbs.	\$ 60.00	LTSD
FSFGPRLS50	Rolled Lava 50 lb. Bag 1-2" - LIMITED TO STOCK ON HAND	50 lbs.	\$ 150.00	LTSD
Burners				
FSFGPH18	18" H-Burner and Connector Kit - LIMITED TO STOCK ON HAND	2 lbs.	\$ 90.00	LTSD
FSFGPH24	24" H-Burner and Connector Kit - LIMITED TO STOCK ON HAND	2.5 lbs.	\$ 110.00	LTSD
FSFGPH30	30" H-Burner and Connector Kit - LIMITED TO STOCK ON HAND	3 lbs.	\$ 120.00	LTSD
FSFGPR18	18" Fire ring Burner - LIMITED TO STOCK ON HAND	4 lbs.	\$ 120.00	LTSD
FSFGPR24	24" Fire ring Burner - LIMITED TO STOCK ON HAND	5 lbs.	\$ 170.00	LTSD
FSFGPR30	30" Fire ring Burner - LIMITED TO STOCK ON HAND	7 lbs.	\$ 210.00	LTSD

